

Starrett®

PRECISION. QUALITY. INNOVATION

SR300 AND SR400 - SURFACE ROUGHNESS TESTER USER GUIDE



Contents



SR300 and SR400 Surface Roughness Tester

SR300 and SR400 Overview

Instrument Overview

Talyprofile

SR300 and SR400 Accessories

Pick-Ups

System Information

Starrett Products

Instructions

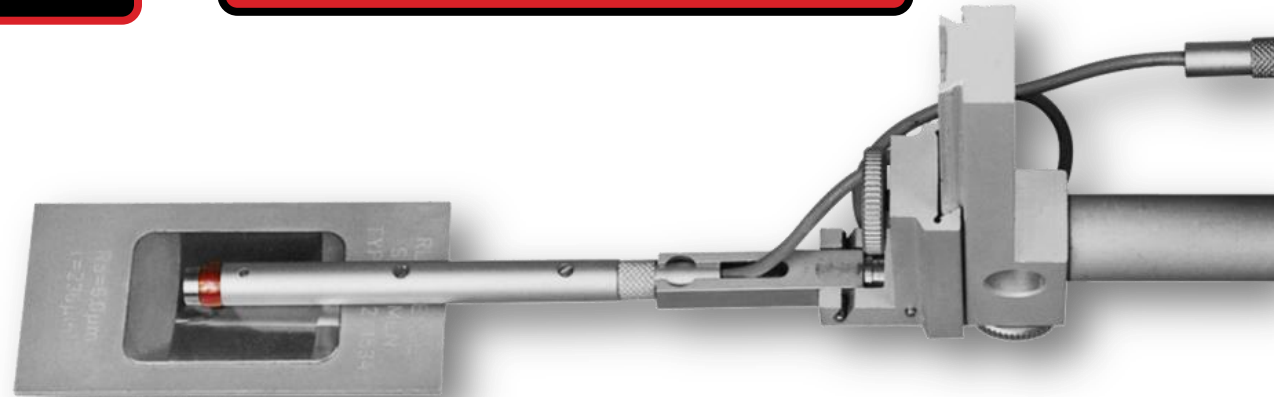



SR300 and SR400 Surface Roughness Tester

SR300 AND SR400 OVERVIEW

SR300 and SR400 Surface Roughness Tester



SR300 and SR400 Surface Roughness Tester

These new editions of Starrett Surface Roughness Testers incorporate a large display with the simplest of menu structures and the most up-to-date parameters. Their mechanical rigidity and styli have a firm reputation for reliable and repeatable surface finish measurements across a wide range of applications.

The SR Surface Roughness Tester comes in two variants: the SR300 is our standard offering, while the SR400 offers extended measurement range and analysis capability.

The SR300 and 400 are battery powered and offers total portability with a built-in memory capacity (holds up to 100 readings). The instrument can be used either freestanding (on horizontal, vertical or even inverted surfaces) or with bench mounted fixtures for batch measurement and laboratory applications.

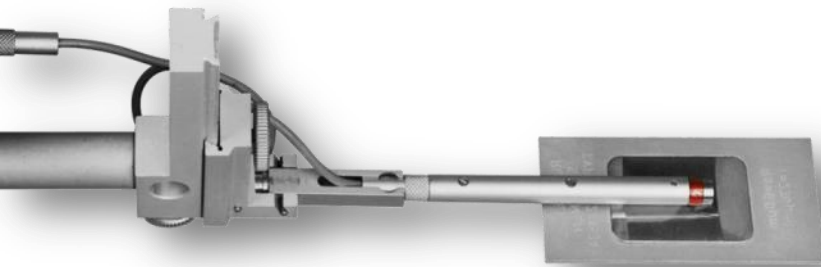
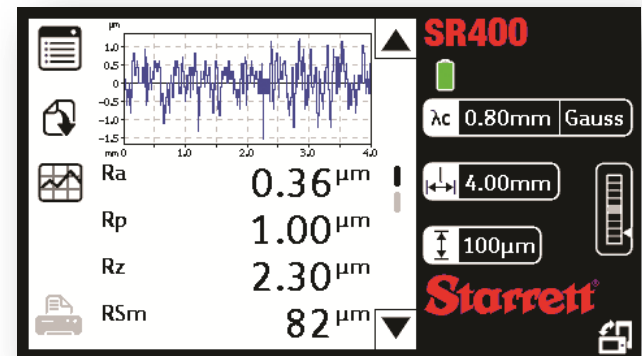

SR300 and SR400 Surface Roughness Tester



SR300 and SR400 Surface Roughness Tester

Durable

- High impact rubberized molding IP44 rated
- Recessed, Mylar protected high durability touch screen
- Solid steel drive mechanism
- Robust anti-wear gears and bearings
- Heavy-duty Li-Poly battery
 - 2000 measurements
 - 5000 hours standby

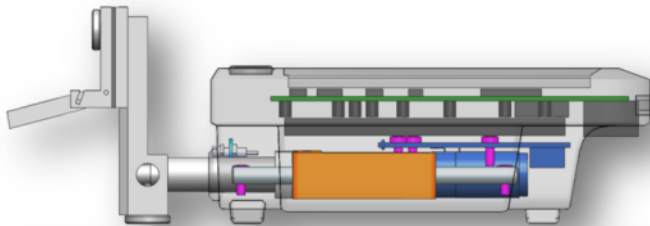

Versatile

- Unique 50mm stylus lift/lower
 - Simple setup on any surface
- Multiple pickups available
 - Small bore, groove, o-ring, etc.
- Measure in any orientation
 - Even upside down
- Evaluation length up to 25mm
- Anti-slip V-feet for flat or curved parts

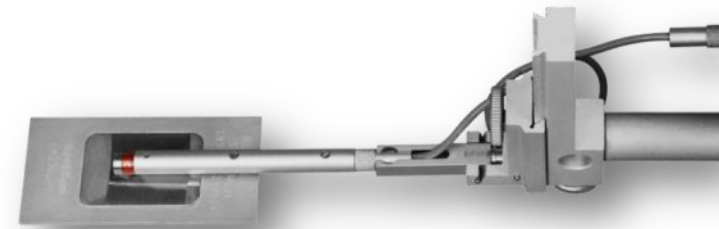

SR300 and SR400 Surface Roughness Tester



SR300 and SR400 Surface Roughness Tester

User-Friendly

- 4.3" daylight readable display
- Operation in any orientation
 - Settings always on display
- Colour touch screen interface
 - Up to 7 results on each page
- Single button measurement
- InstantOn™ < 1 second restart

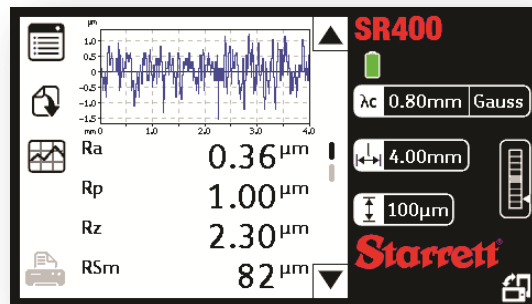

Connectivity

- Standard USB Charging (PC or Mains)
- Storage of results internal or USB key
 - 100 internal, >10,000 on USB
- USB to PC for advanced analysis
 - Includes free Talyprofile software
- USB remote Settings and Measurement
- Standard USB Printing (ESC/POS)



SR300 and SR400 Surface Roughness Tester



SR300 and SR400 Surface Roughness Tester



Measuring Flat or Cylindrical Surfaces

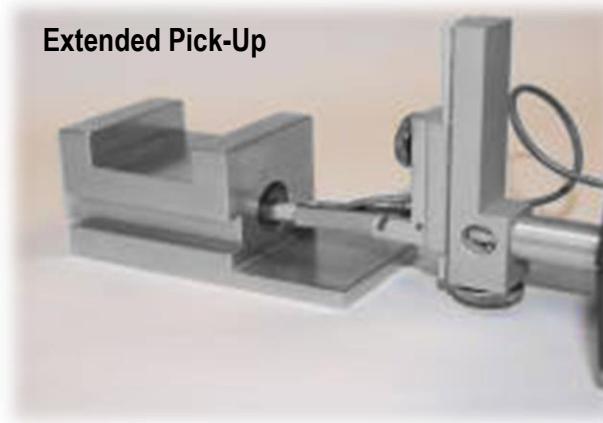

Extended Pick-Up

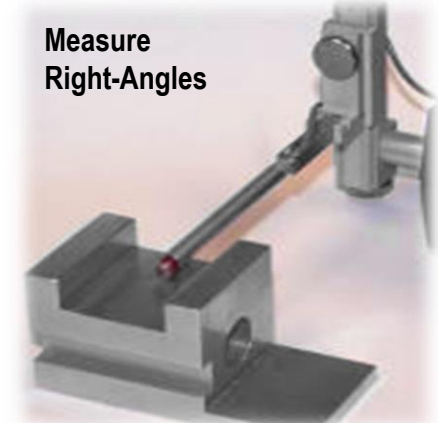

Measure Right-Angles

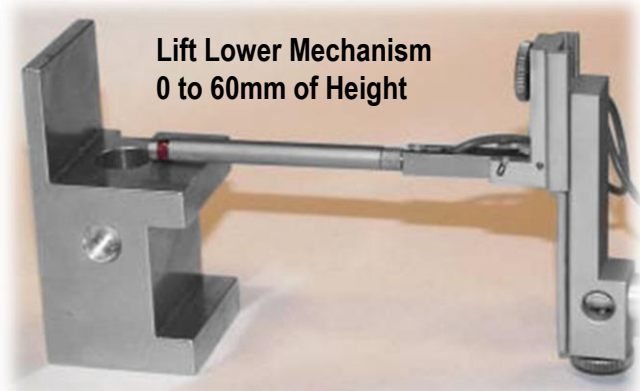

Lift Lower Mechanism
0 to 60mm of Height



Built in Memory
as Standard

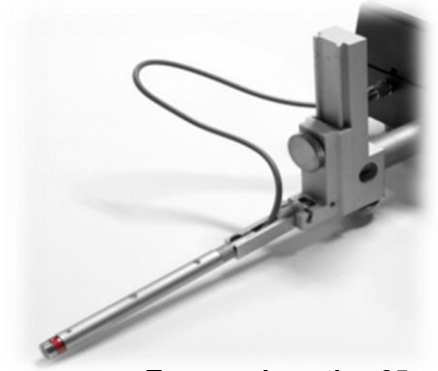

Traverse Length = 25mm

SR300 and SR400 Surface Roughness Tester



SR300 and SR400 Surface Roughness Tester

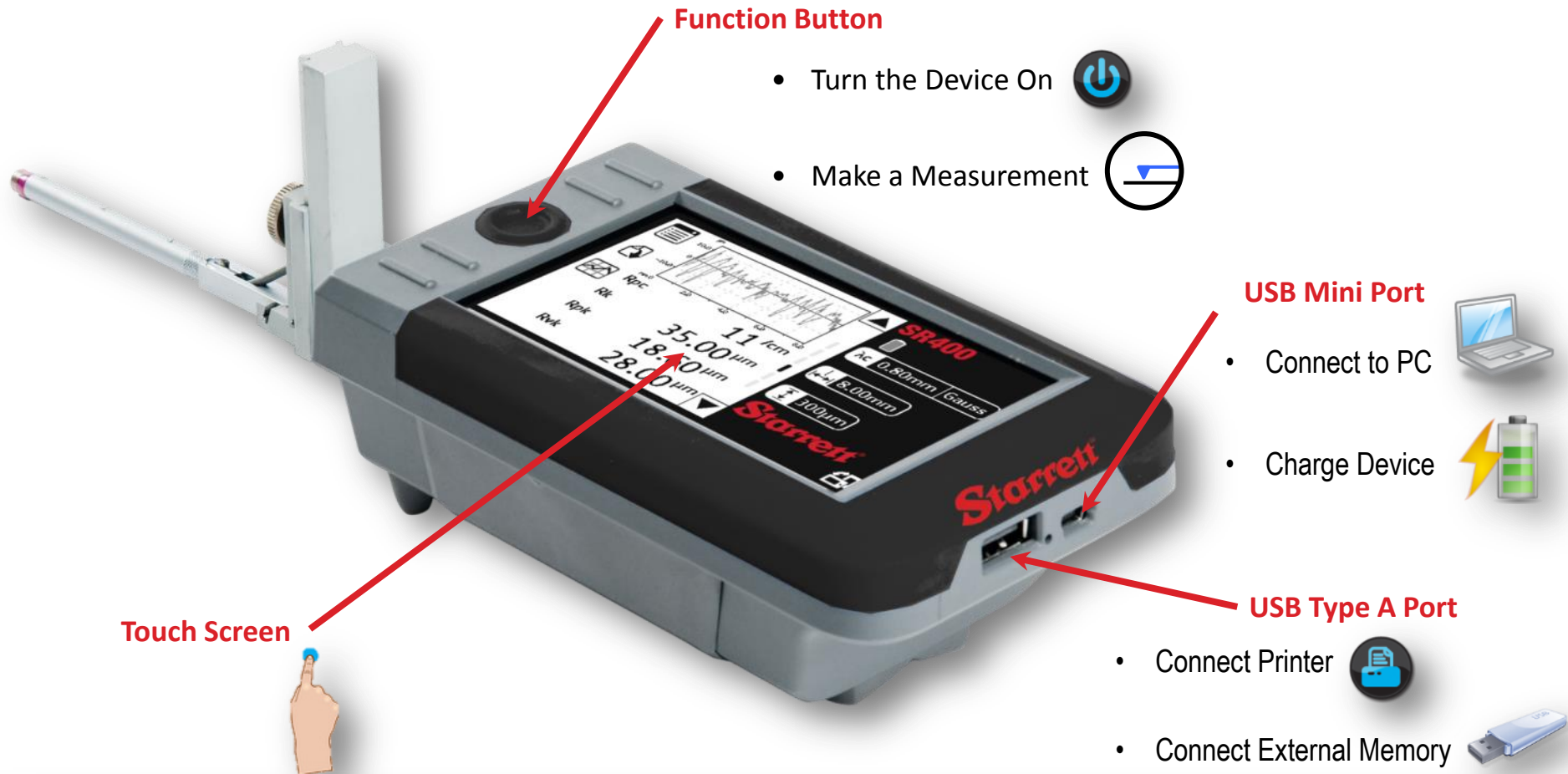

SR300 and SR400 Surface Roughness Tester



SR300 and SR400 Surface Roughness Tester

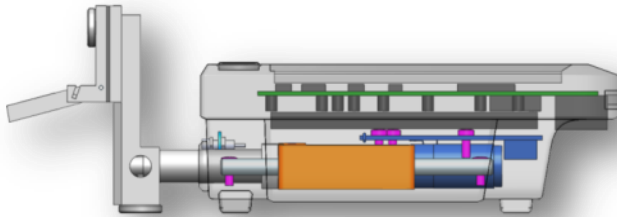

Parameter Options to Suit Your Application

Fast Measurement Cycle

Intuitive Menu Structure

Unique Stylus Lift Mechanism for Total Flexibility

Long Traverse Length and Extended Pick-Up Reach

Comprehensive Range of Accessory and Pick-Up Options

Storage of Up to 100 Readings

Powerful Software Option

World Class Technical Support

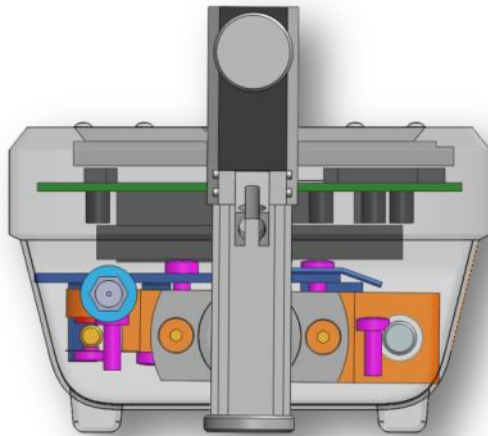



SR300 and SR400 Surface Roughness Tester

INSTRUMENT OVERVIEW

Instrument Overview



SR300 and SR400 Surface Roughness Tester

Parameter Options to Suit Your Application

The SR300/SR400 can calculate up to 22 parameters according to your measurement application including:

Amplitude Parameters

Measures the vertical characteristics of the surface deviations:

- **Ra** (Arithmetic Mean Deviation)
- **Rsk** (Skewness)
- **Rz** (Average peak to valley height)
- **Rt** (Total height of profile)
- **Rp** (Max profile peak height)
- **Rz1max** (Max peak to valley height)

Spacing Parameters

Measures the horizontal characteristics of the surface deviations:

- **RPc** (Peak count)
- **RSm** (Mean width of profile elements)

Hybrid Parameters

Combinations of spacing and amplitude parameters:

- **Rmr** (Material Ratio)
- **Rda - R Delta a** (Arithmetic Mean Slope)

The above parameters cover the most common requirements to check lubrication, feed rates, stresses, friction and wear properties.

Additional parameters can be analysed with the addition of Talyprofile software.



Fast Measurement Cycle

The SR300/SR400 incorporates the latest electronics for very fast analysis - results are calculated and displayed even before the traverse unit returns. This fast processing, combined with intuitive menu buttons, greatly reduces measurement cycles.

Powerful Software Options

The SR300/SR400 includes Type A USB and USB mini ports which allow connection to a printer or exportation of results to a PC for further analysis using the optional Talyprofile software. By setting the SR300/SR400 to 'Data Dump' mode, measurements can be instigated directly from the Talyprofile software.

Intuitive Menu Structure

The SR300/SR400 incorporates a large LCD screen which allows full menu and measurement results to be displayed. Using only two buttons the user can scroll through the menus and make selections intuitively before pressing the MEASURE key. All selections are saved for future measurements. All the measurement criteria and results are displayed clearly on the screen ready to print or export to a PC.



Unique Stylus Lift Mechanism

The SR300/SR400 has a uniquely engineered stylus lift mechanism which allows a vertical adjustment of 50mm and rotation of the pick-up to different measuring positions, including right angle or inverted measurements. These adjustments to the height and position of the gauge allow areas and features of a part to be easily measured without additional fixtures. This feature saves the operator a huge amount of set up time and allows total flexibility. Typical applications where the stylus lift is invaluable include the measurement of steps, bores, grooves and lands.

Built-in Memory/Storage

No PC or printer cables in your way while you measure – the SR300/SR400 is now truly portable: Take your surface roughness tester wherever you need to take measurements, save as many batch readings as you need (max 100 measurements) then download to your PC or printer at your convenience.

External Memory

Storage is expandable with a standard USB stick. The 4 GB USB stick provided with the unit is capable of storing over 64,000 screen shots and/or measurements



Long Traverse Length and Extended Pick-Up Reach

The SR300/SR400 can traverse up to 25mm (or as little as 0.25mm) depending on your component. In addition, the stylus length and pick-up configuration give a long reach, making it an ideal instrument for features such as large and narrow bores. Optional extension rods extend the pick-up further.

Comprehensive Range of Accessories and Pick-Ups

Starrett has developed an extensive range of pick-ups and accessories to suit the varied measurement needs of our customers. In addition to the pick-ups shown on page 6 our applications department regularly designs and manufactures pick-ups and fixtures for specific requirements.



SR300 and SR400 Surface Roughness Tester

TALYPROFILE

PRECISION, QUALITY INNOVATION

Starrett[®]



Talyprofile

SR300 and SR400 Surface Roughness Tester

Advanced Surface Finish Analysis

Talyprofile is a dedicated software package designed for use with workshop or laboratory instruments.

Three versions are available:

- Talyprofile “**Silver**” has all functions typically used for a shop floor inspection.
- Talyprofile “**Gold**” has complete laboratory analysis functions.
- Talyprofile “**Lite**” is a free download, available from ‘talyprofile.com’
 - Click the button below to open the website.

Talyprofile.com

TalyProfile Lite

For full feature list and software levels - [please click here](#)

Please fill in your details to download a free copy of TalyProfile Lite

Name

Company

Country

Email

Address

City

Telephone No.

Postal/Zip Code

Instrument Type

Product Serial Number

Instrument Supplier

Industry

Application Type

[Accept Terms & Conditions](#)

Talyprofile



SR300 and SR400 Surface Roughness Tester

General Features		Gold	Silver	Lite	Modules			Key	
Acquisition interface for workshop profilers		✓	✓	✓				✓	Included
Basic set of file formats		✓	✓					⇒	Available in Optional Module(s)
Can be used without USB dongle	V6	✓	✓	✓				STA	Statistics
Desktop publishing and template document		✓	✓	✓				CT	Contour
File formats of 2D profilers		✓	✓					ACT	Advanced Contour
Manage parametric profiles	V6	⇒			CT	ACT			
Management of non-measured points		⇒			CT	ACT			
Minidocs	V5	✓	✓						
Series of profiles enabled		✓	✓						
Statistics enabled	V5	⇒	⇒						STA
Table of results	V5	⇒					ACT		
Template of document on all data of a folder		✓	✓						STA
Third party plug-ins		✓							
Tolerance limits (pass/fail)		✓	✓						

Talyprofile



SR300 and SR400 Surface Roughness Tester

Interface		Gold	Silver	Lite	Modules		
Analysis workflow	V5	✓					
Document pages viewer	V5	✓	✓	✓			
File explorer and favorite folders	V5	✓	✓				
Interactive bank of studiabiles		✓	✓	✓			
Languages: EN, FR, DE, ES, IT, PL, JP, CH, KR		✓	✓	✓			
Masterpages	V5	✓	✓				

Key	
✓	Included
⇒	Available in Optional Module(s)
STA	Statistics
CT	Contour
ACT	Advanced Contour

Operators on Profiles		Gold	Silver	Lite	Modules		
Filtering		✓					
Filtering by direct edition of the FFT		✓					
Filtering by threshold of the FFT	V5	✓					
Form removal		✓					
Join two profiles		✓					
Leveling		✓	✓	✓			
Resampling		✓					
Retouch profile points		✓					
Symmetries		✓	✓	✓			
Thresholding		✓					
Zoom		✓	✓	✓			

Talyprofile



SR300 and SR400 Surface Roughness Tester

Studies on Profiles		Gold	Silver	Lite	Modules			Key	
Abbott-Firestone curve/depth distribution		✓	✓	✓				✓	Included
Advanced options in contour analysis	V6	⇨				ACT		⇨	Available in Optional Module(s)
Area of a hole/peak		✓	✓					STA	Statistics
Averaged power spectrum density		✓						CT	Contour
Contour analysis		⇨			CT	ACT		ACT	Advanced Contour
Distance measurement		✓	✓	✓					
Fractal analysis		✓							
Frequency Spectrum		✓							
Graphical study of Rk parameters		✓							
Morphological envelopes		✓							
Profile curve		✓	✓	✓					
Profile parameters study		✓	✓	✓					
R&W motifs (ISO 12085)		✓							
Rk calculation profiles		✓							
Roughness and waviness profile curves		✓	✓	✓					
Step height measurement		✓							
Waviness parameters of groups A and/or B		✓	✓						

Talyprofile



SR300 and SR400 Surface Roughness Tester

Parameters	Gold	Silver	Lite	Modules
2D (P+R) parameters, Group A: ISO 4287	✓	✓	✓	
2D (P+R) parameters, Group B: old parameters	✓			
2D parameters, Group C: automotive	✓			

Operators on Series of Profiles	Gold	Silver	Lite	Modules
Profile extraction	✓	✓		

Studies on Series of Profiles	Gold	Silver	Lite	Modules
Profile curves of the series	✓	✓		

Key	
✓	Included
⇒	Available in Optional Module(s)
STA	Statistics
CT	Contour
ACT	Advanced Contour

Talyprofile



SR300 and SR400 Surface Roughness Tester

Operators on Surfaces	Gold	Silver	Lite	Modules
Profile extraction	✓	✓		

Studies on Surfaces	Gold	Silver	Lite	Modules
Pseudo-color image	✓	✓		

Studies of the Statistical Module		Gold	Silver	Lite	Modules
Box plot	V5	⇒	⇒		STA
Histogram	V5	⇒	⇒		STA
Scatter plot	V5	⇒	⇒		STA
Table of statistical parameters	V5	⇒	⇒		STA
Trend plot	V5	⇒	⇒		STA

Key	
✓	Included
⇒	Available in Optional Module(s)
STA	Statistics
CT	Contour
ACT	Advanced Contour

Talyprofile



SR300 and SR400 Surface Roughness Tester

Time-Saving Templates

A 'template' can be created whereby a sequence of analytical functions can be saved and applied to future measurements, turning detailed reporting tasks into routine documents.

Desktop Publishing Facility

Talyprofile offers a comprehensive desk top publishing function which allows professional presentation of measurement results and profiles. Graphs, profiles and results can be arranged and printed from within the Talyprofile software or copied into other word-processing documents giving complete flexibility in reporting.

Full Compatibility

Surface finish results from other Starrett surface roughness instruments can be imported to Talyprofile software, allowing a uniform report style to be used throughout your workshop or laboratory.

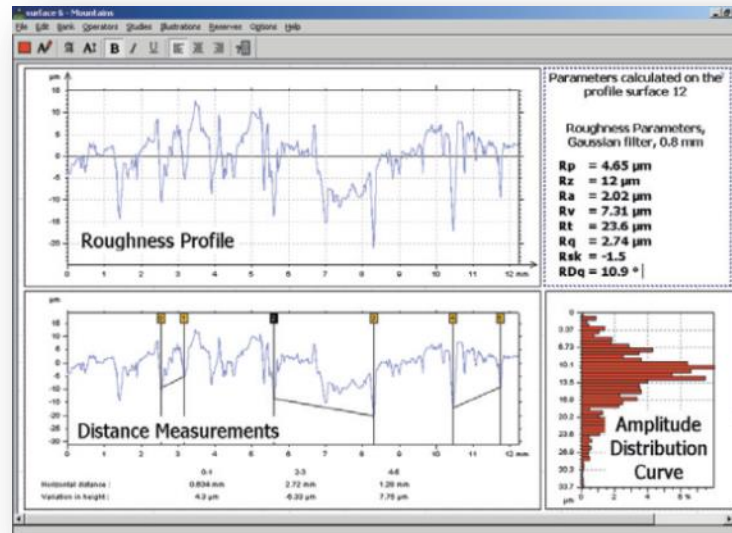



Talyscope Parameters

Roughness Parameters

Obtained by Filtering: **Ra, Rq, Rt, Rp, Ry, Rku, Rsk, RSm, Rz, RΔq, RTp, RHTp, Rlo, Rλq, RPC, RzJIS, R3z.**

Waviness Parameters

Obtained by Filtering: **Wa, Wq, Wt, Wp, Wv, Wku, Wsk, WSm, Wz, WzJIS, Wλq, WΔq, WTp, WHTp, WLo, WPC, W3z.**

(only with Gold version and instruments with straightness datum)

Parameters on the Raw Profile

Unfiltered: **Pa, Pq, Pt, Pp, Pv, Pku, Psk, PSm, Pz, PΔq, Pλq, PTp, PHTp, PLo, PPc.**

Parameters Obtained by Double Filtering

DIN 4776: **Rk, Rpk, Rvk, MR1, MR2, A1, A2, Rvk.**

(only with Gold version)

Parameters Obtained by the Motifs Method

"R&W": **R, AR, Pt, Rx, SR, SAR, Nr, Kr, W, AW, Wte, Wx, SW, SAW, Nw, Kw, Rke, Rpke, Rvke, Trc, HTrc.**

(only with Gold version)

Talyprofile



SR300 and SR400 Surface Roughness Tester

Outstanding Graphics

The software is visually advanced and provides clear on screen profile images. Talyprofile allows the user to take a basic measurement and create a full measurement report using the software's detailed analysis options and desktop publishing function

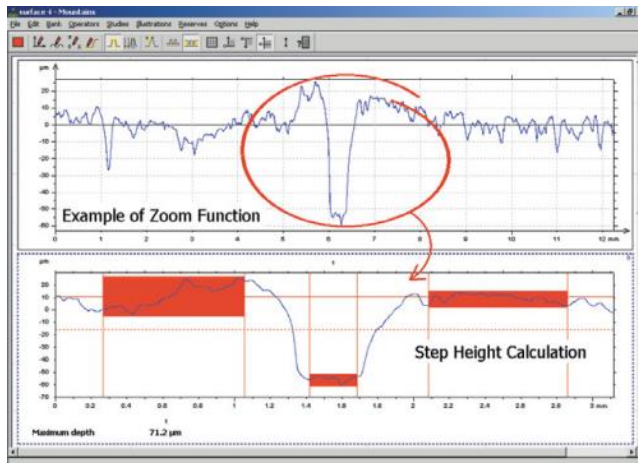

In Depth Analysis

Profiles can be levelled and zoomed to remove unwanted features or defects from the analysis. Distance measurement between features and areas of a profile are easily implemented and the information can be displayed graphically and numerically. Step height and the area of a hole or peak can also be displayed.

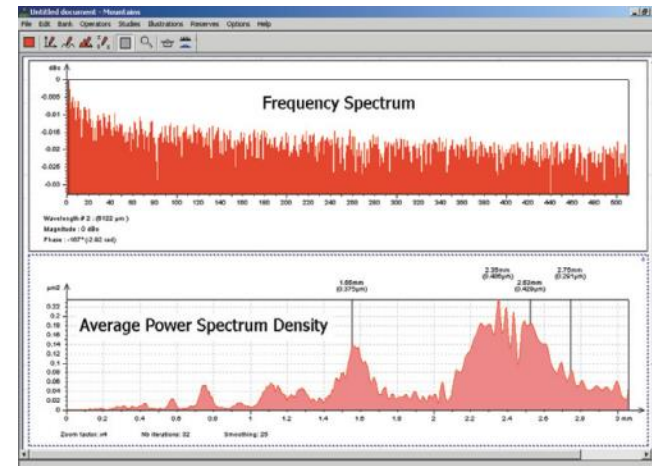



SR300 and SR400 Surface Roughness Tester

SR300 AND SR400 ACCESSORIES



SR300 and SR400 Accessories

SR300 and SR400 Surface Roughness Tester

USB Thermal Printer

Cat. No. SR-112-4570

Compact and highspeed 60mm (24in)/second. Includes USB lead and International Power Supply Outputs settings, results, and high resolution graph.



SR300 and SR400 Accessories



SR300 and SR400 Surface Roughness Tester

Support Stand

Cat. No. SR-112-1517

With 4 degrees of freedom. Max measuring height of 430 mm and a range of 115 mm at a horizontal reach of 305–420 mm.



Column and Stand

Cat. No. SR-112-2693

Granite base (400 x 250 mm) with manually operated column providing adjustment height of 260 mm



SR300 and SR400 Accessories



SR300 and SR400 Surface Roughness Tester

Plug Adaptors

Cat. No. SR-112-4545

International USB charger

- 5V 1A 110-240VAC
- 50/60Hz

Recharges SR300/SR400 in 4 hours.



SR300 and SR400 Accessories



SR300 and SR400 Surface Roughness Tester

Height Transfer Gage

Cat. No. 252Z-14

Clamp

Part No. PT99560

Clamp to attach SR300 and SR400 to
252 Height Transfer Gage





SR300 and SR400 Surface Roughness Tester

PICK-UPS

Pick-Ups



SR300 and SR400 Surface Roughness Tester

Starrett has developed an extensive range of pick-ups to suit the varied measurement needs of our customers. In addition to the pick-ups shown below our applications department regularly design and manufacture pick-ups for specific requirements.

Standard Pick-Up

Cat. No. SR-112-1502

For general surface roughness measurement. Also available with $10\mu\text{m}$ ($400\mu\text{in}$) tip radius. (code 112-1503)

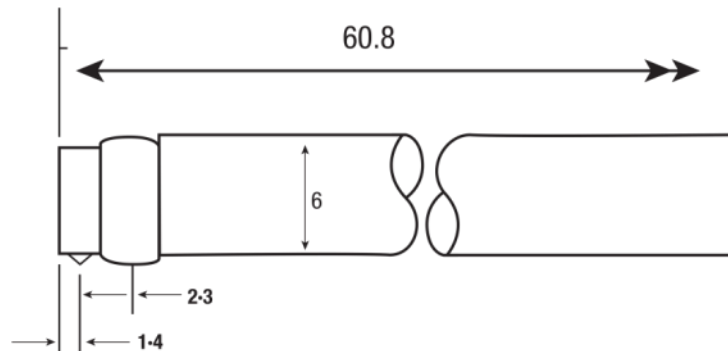

Small Bore Pick-Up

Cat. No. SR-155-P28495

For general use in small bores, grooves and on narrow surfaces.

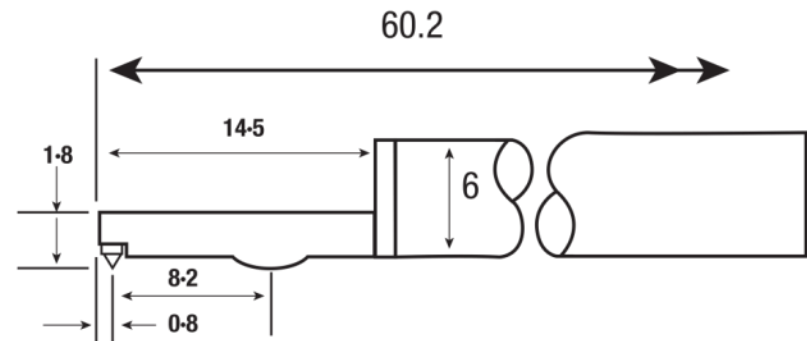

Right Angle Pick-Up

Cat. No. SR-112-1505

For measurement at right angles to the direction of traverse.

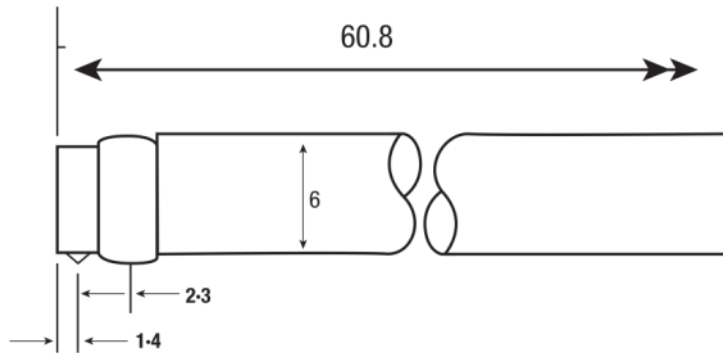

Recess Pick-Up

Cat. No. SR-112-1506

For recesses to a depth of 5.7mm (0.23in). A 2 μ m tip radius version is available (code 112-2672). (Also available for 25mm depth.)

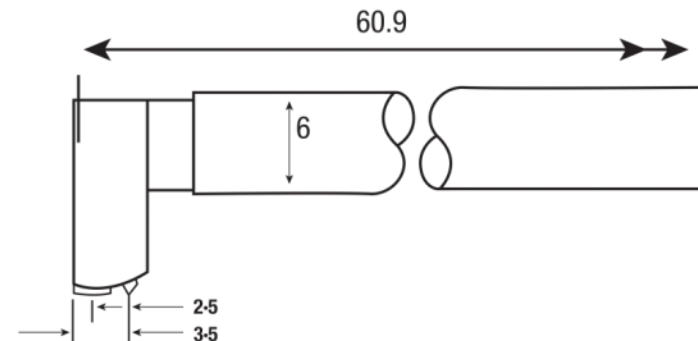



SR300 and SR400 Surface Roughness Tester

Technical Specifications and Dimensions

SYSTEM INFORMATION

Technical Specifications



SR300 and SR400 Surface Roughness Tester

Technical		SR300	SR400
Languages	Basic	English, French, German, Italian, Spanish	
	Extended		
	Asian		
Data Output	On-Screen	Up to 7 results per page, selectable on-screen graph with XZ axis	
	Printer	Output settings, results and high resolution profile graph	
	PC Connection	Full data analysis with Talyprofile	
Data Storage	Internal	100 measurement results, 1 raw profile	
	USB (4GB supplied)	>39,000 raw profiles, up to 100,000 results per batch (>70 batches)	
	PC Connection	Unlimited data storage	
SPC/Stats	Internal	Optional	Min, Max, Mean, StdDev of stored results
	USB (4B supplied)	Optional	ASCII export of all results for SPC
	PC Connection	Full SPC and tolerancing of all parameters using Talyprofile software	
Battery	Charger	USB 5v 1A 110-240VAC 50/60Hz	
	Charging Time	4 hours	
	Battery Life	2,000 measurements	
	Standby Time	5,000 hours	
	InstantOn	Max 1 sec from standby to ready to measure	
	Auto Sleep Function	30 sec – 6 hours	

Technical Specifications



SR300 and SR400 Surface Roughness Tester

Component Capacity		SR300	SR400
Physical Specifications	Weight Including Pickup	0.5Kg (1.1lbs)	
	IP Rating	None	IP43
	Power Source	Li Poly rechargeable battery	
Operating Conditions	Temperature	5 - 40°C (41-104°F)	
	Humidity	0 -80% non-condensing	
Storage Conditions	Temperature	0 -50°C (32 - 122°F)	
	Humidity	0 – 90% non-condensing	

Dimensions



SR300 and SR400 Surface Roughness Tester

Measurement Capability		SR300	SR400	
Gage	Range	200µm, 100µm, 10µm	400µm, 100µm, 10µm	
	Resolution	100nm, 20nm, 10nm	50nm, 10nm, 5nm	
	Noise Floor (Ra)	250nm, 150nm, 100nm	150nm, 100nm, 50nm	
	Repeatability (Ra)	1% of value + noise	0.5% of value + noise	
	Pickup Type	Inductive		
	Gage Force	150 – 300mg		
	Stylus Tip Radius	5µm (200µin default/2µm (80µm) or 10µm (400µm) optional		
	Measurement Type	Skidded		
	Calibration	Process	Automated software calibration routine	
		Standards	Able to calibrate to ISO 4287 roughness standards	
Analysis	Filter Cut-Off	0.25mm/0.8mm/2.5mm		
	Filter Type	2CR/Gaussian		
	Evaluation Length	0.25mm – 12.5mm (0.01in - 0.49in)	0.25mm – 25.0mm (0.01in – 0.98in)	
	Max X Axis Range	17.5mm	25.5mm	
Speed	Measuring Speed	1mm/sec (0.04in/sec)		
	Returning Speed	1.5mm/sec (0.06in/sec)		

Dimensions



SR300 and SR400 Surface Roughness Tester

Analysis Capability		SR300	SR400
Parameters	Standards	ISO 4287, ISO 13565-1, ISO 13565-2, ASME 46.1, JIS 0601, N31007	
	ISO Basics	Ra, Rv, Rp, Rz, Rt, Rq, Rsk, Rmr, Rdq, RSm, Rz1max	
	ISO Advanced	Optional	Rk, A1, A2, Mr1, Mr2, Rpk, Rvk
	ASME	Ra, Rv, Rp, Rz, Rt, Rq, Rsk, Rdq, RSm, Rpm, Rda	
	JIS	Ra, Rv, Rp, Rz, Rt, Rq, Rsk, Rmr, Rdq, RSm, RzJIS, Rc, Rku, Rdc	
	Other	R3z (Daimler Benz)	
	ISO Primary	Optional	Pa, Pv, Pp, Pz, Pt, Psk, Pmr, Pdq, Ppc, PSm, Pz1max
	Units	μm/μin	



SR300 and SR400 Surface Roughness Tester

OTHER STARRETT PRODUCTS

PRECISION, QUALITY INNOVATION

Starrett[®]



Other Starrett Products

SR300 and SR400 Surface Roughness Tester

SR160 – Surface Roughness Tester

This surface roughness tester is simple, accurate, and of high-quality. It performs a wide variety of parameters, from common Ra to more complex Rz1Max and Rsk parameters. The design makes the device simple to navigate, intuitive, and reliable. Of the highest in Starrett quality. Skidded pick-up with 5 μ m (200 μ in) stylus tip.





SR300 and SR400 Surface Roughness Tester

INSTRUCTION MENU

Instruction Menu



SR300 and SR400 Surface Roughness Tester

Menu

Device Icons

Graph

Battery

Brightness

Internal Memory

External Memory

Rotate

Screen Shot

Battery Level

Calibration

Calibration Value

Calibration Filter

Calibration Settings

Stylus Return

Cut-Off

Filter Type

Measurement Length

Range

Set Zero

Parameters

Parameter Settings

Units

Storage

New Batch

Keyboard

View Batch

Delete Batch

Print Batch

Print

Language

Sleep Timer

Instructions

Instruction Menu



SR300 and SR400 Surface Roughness Tester

Menu

Tap the “Menu” icon in the left-hand corner.

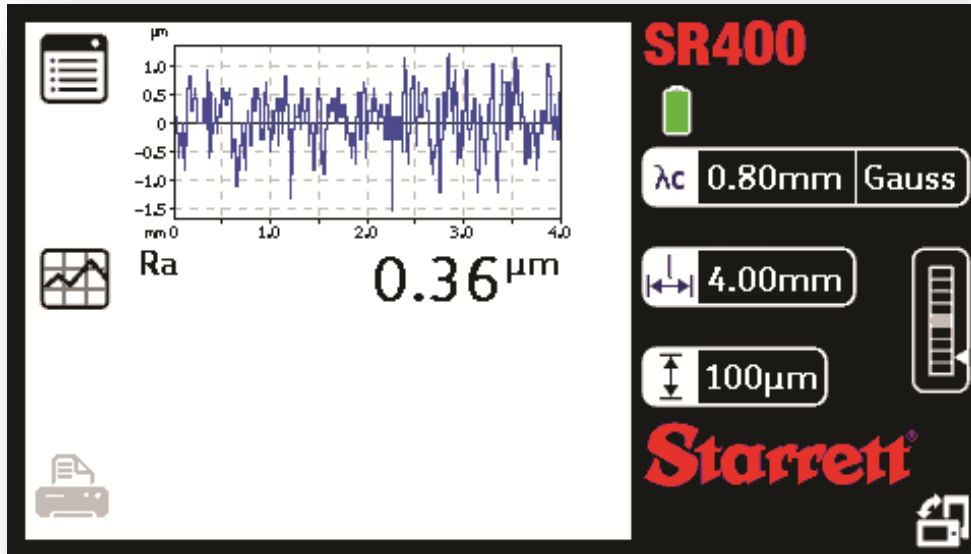

Tap the “Down Arrow” to scroll down through the menu.

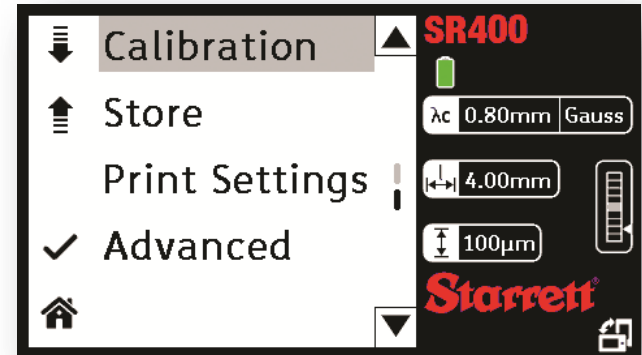
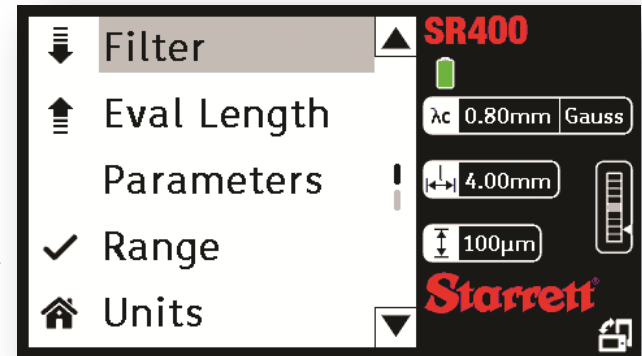

Instructions

Instruction Menu



SR300 and SR400 Surface Roughness Tester

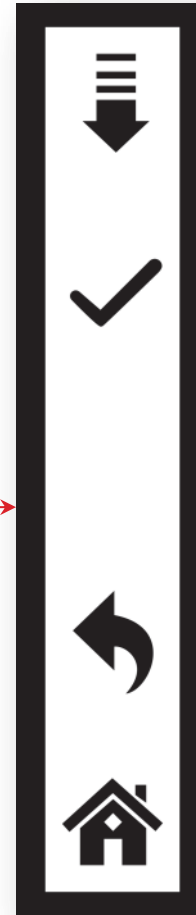
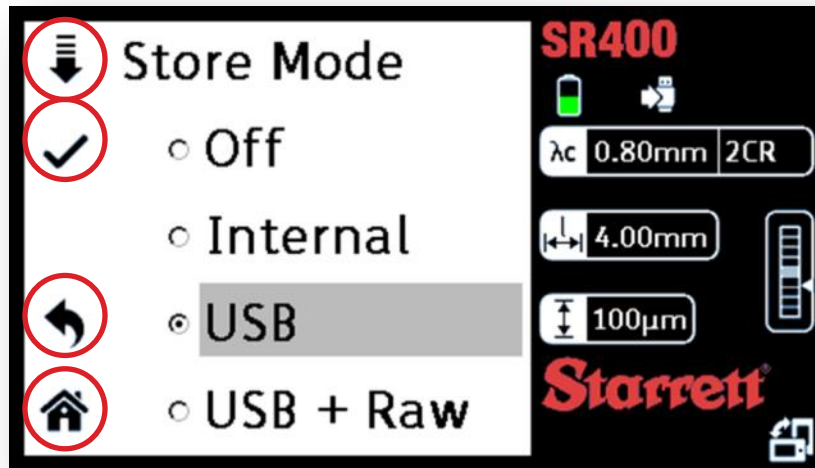

Tap the 'Arrow' icon to move down to the next item in a list.

Tap the 'Tick' icon to confirm your selection or data input.

Tap the 'Return' icon to return to the previous screen.

Tap the 'Home' icon to return to the Home screen.

Instructions

Instruction Menu



SR300 and SR400 Surface Roughness Tester

Graph

Tap the “Graph” icon on the left-hand side of the screen to view a graph of your measurement.

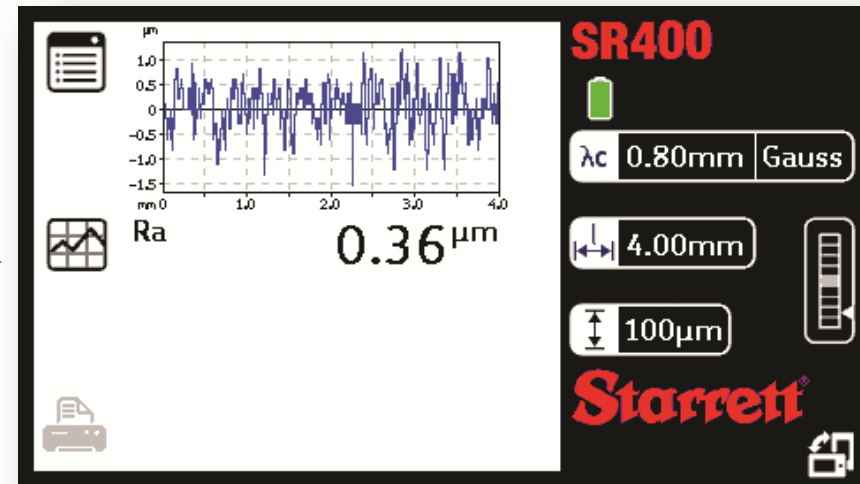
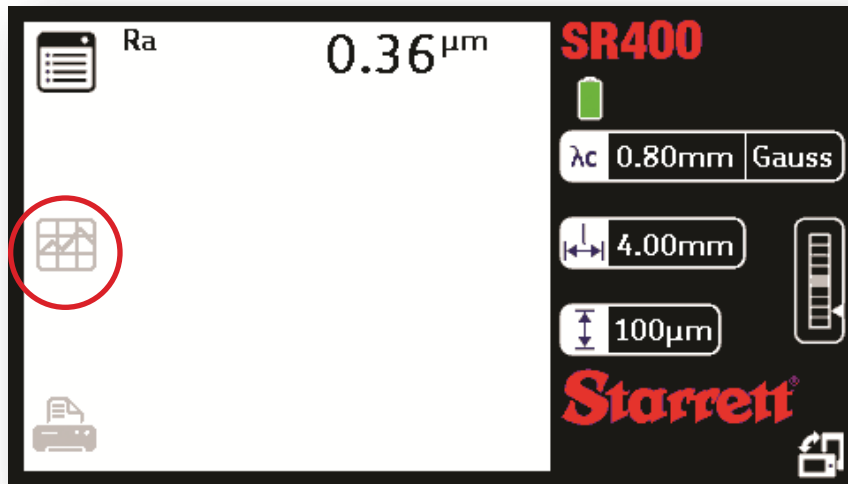

Instructions

Instruction Menu



SR300 and SR400 Surface Roughness Tester

Battery

This icon indicates the SR300/SR400 current Battery life.

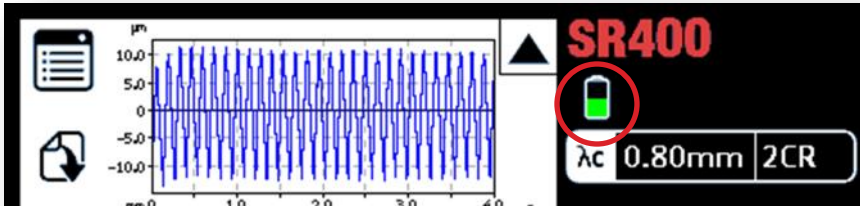

This icon indicates that the SR300/SR400's battery is charging.

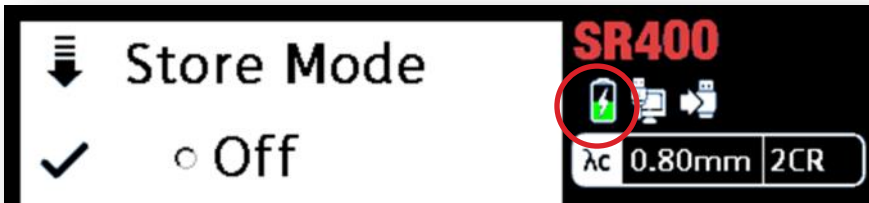

Internal Memory

This icon indicates that the data is saved to internal memory.



External Memory

This icon indicates that the data is saved to an external memory source.

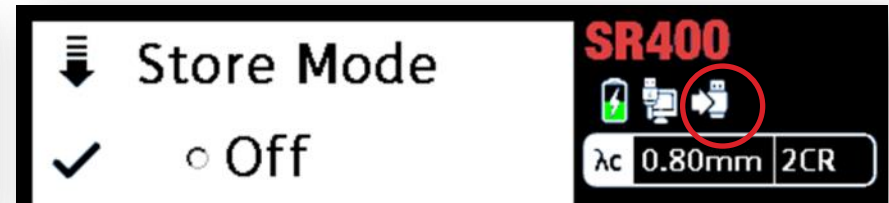

Instructions

Instruction Menu



SR300 and SR400 Surface Roughness Tester

Rotate

Tap the "Rotate" icon to rotate the screen between landscape and portrait mode.

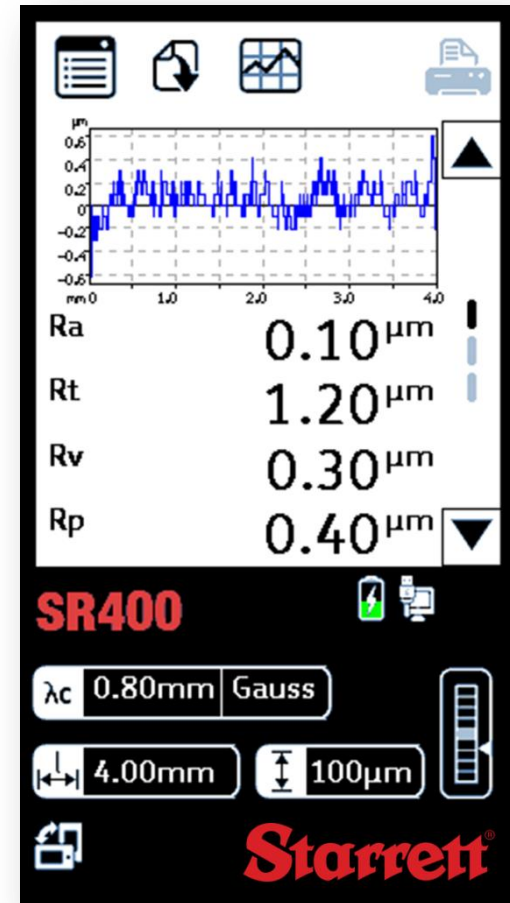
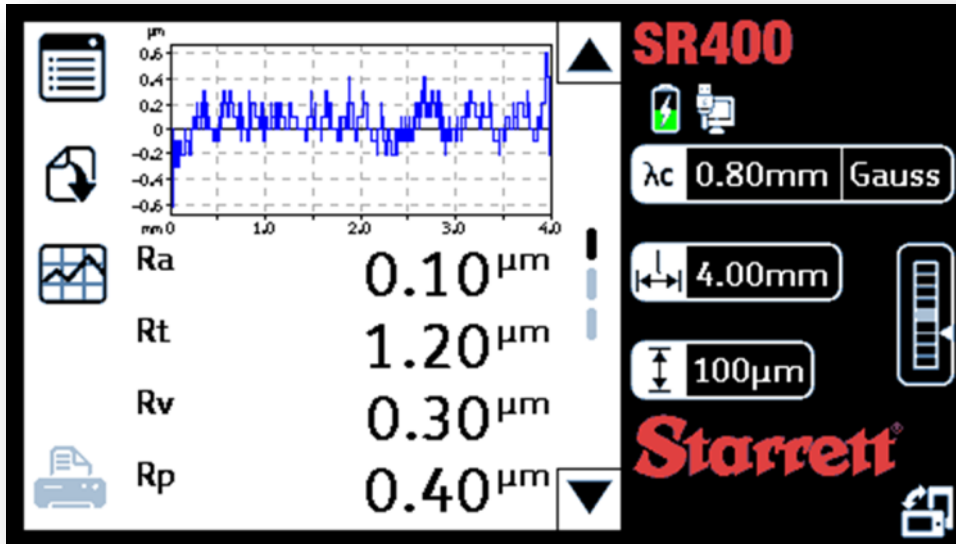

Instructions

Instruction Menu



SR300 and SR400 Surface Roughness Tester

Rotate

Tap "Starrett" icon to take a screen shot of the device.

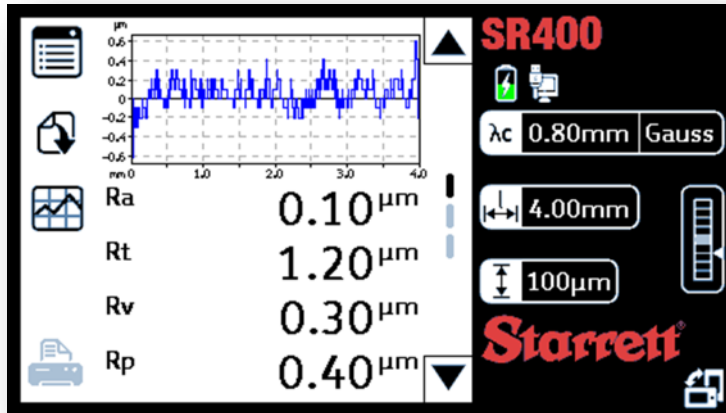

The screen shot saved to the external USB drive.

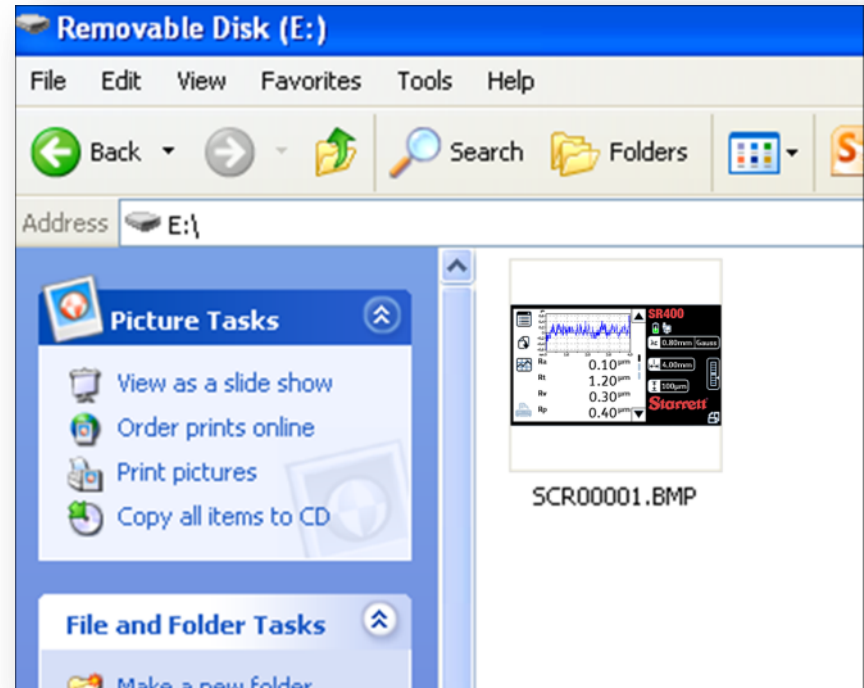

Instructions

Instruction Menu



SR300 and SR400 Surface Roughness Tester

Calibration

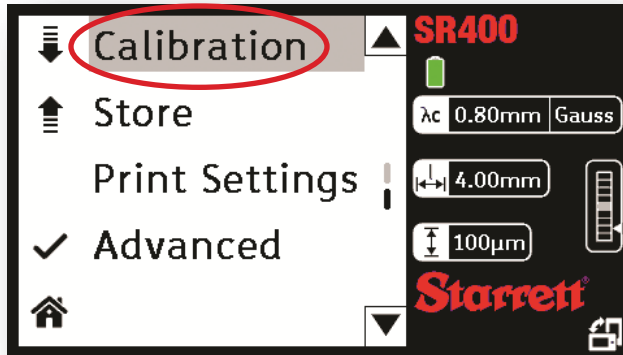

Tap 'Calibration' and then the 'Settings' icon to see a list of calibration options.

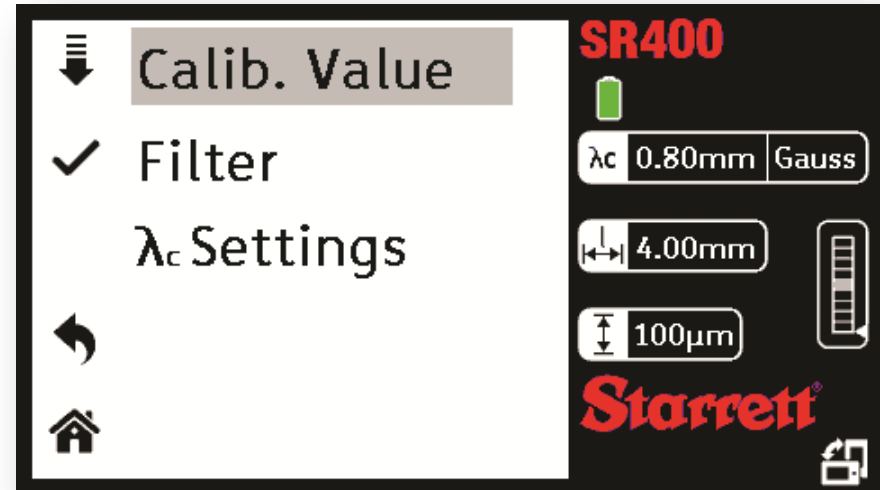
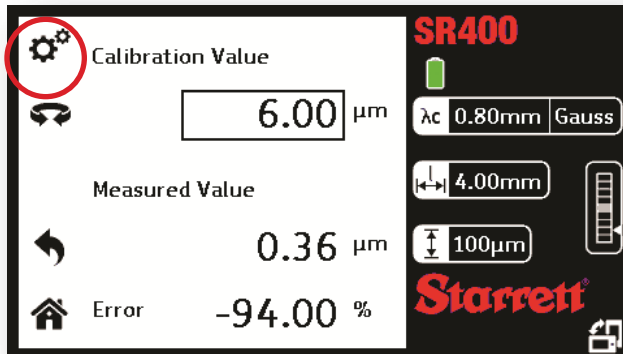

Instructions

Instruction Menu



SR300 and SR400 Surface Roughness Tester

Calibration Value

Tap 'Calib. Value' and enter the value you require.
Tap the "Save" icon to save the calibration value.

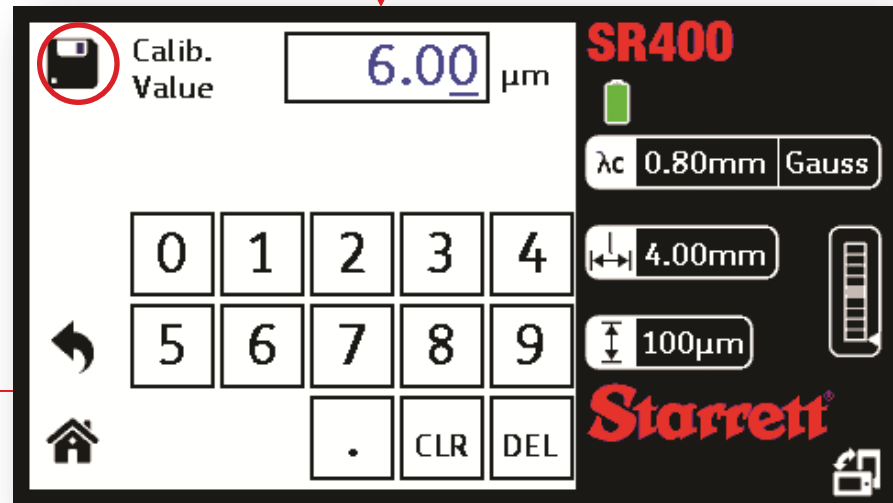
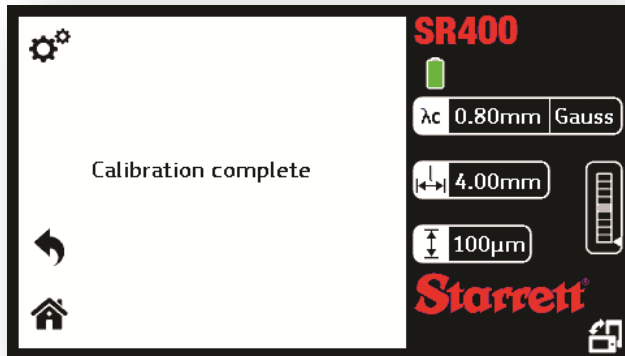
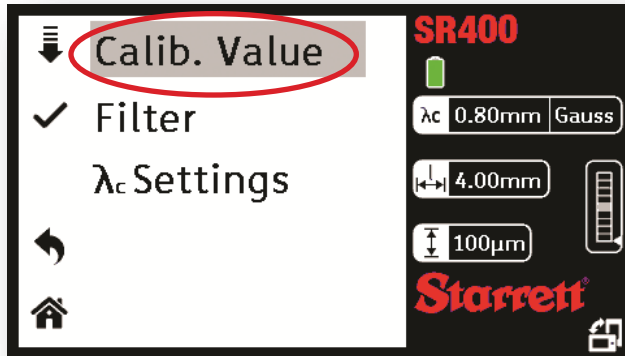

Instructions

Instruction Menu



SR300 and SR400 Surface Roughness Tester

Calibration Filter - Type

Tap "Filter" and then "Type" to select your required filter option.

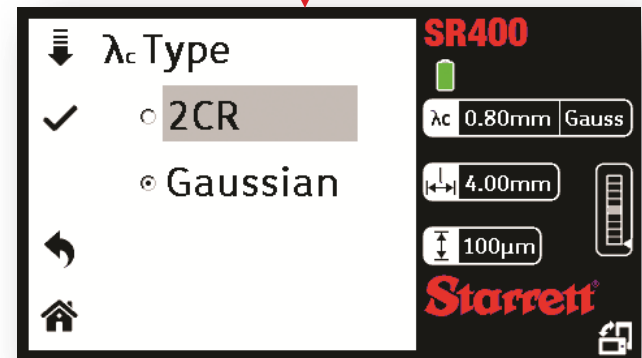
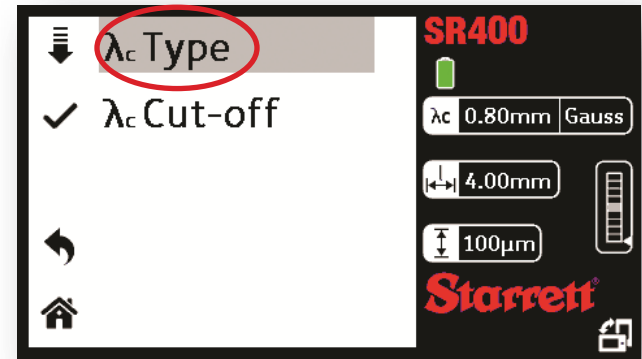
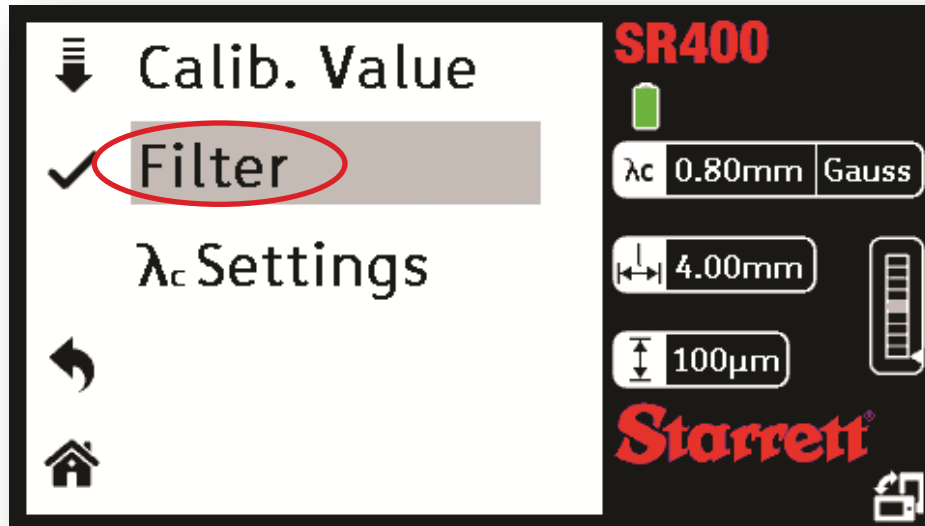

Instructions

Instruction Menu



SR300 and SR400 Surface Roughness Tester

Calibration Filter – Cut Type

Tap “Filter” and then “Cut-Off” to select your required cut-off option.

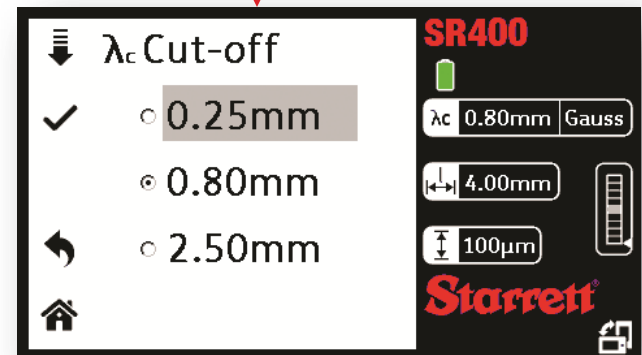
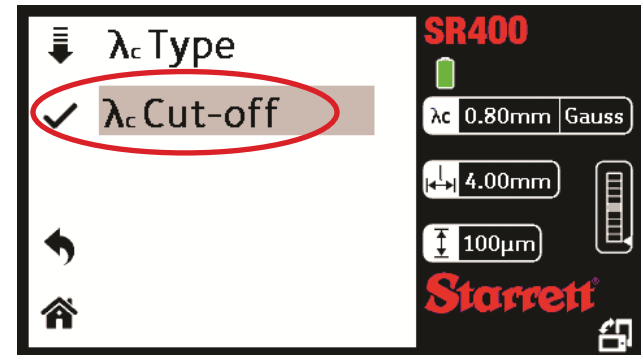
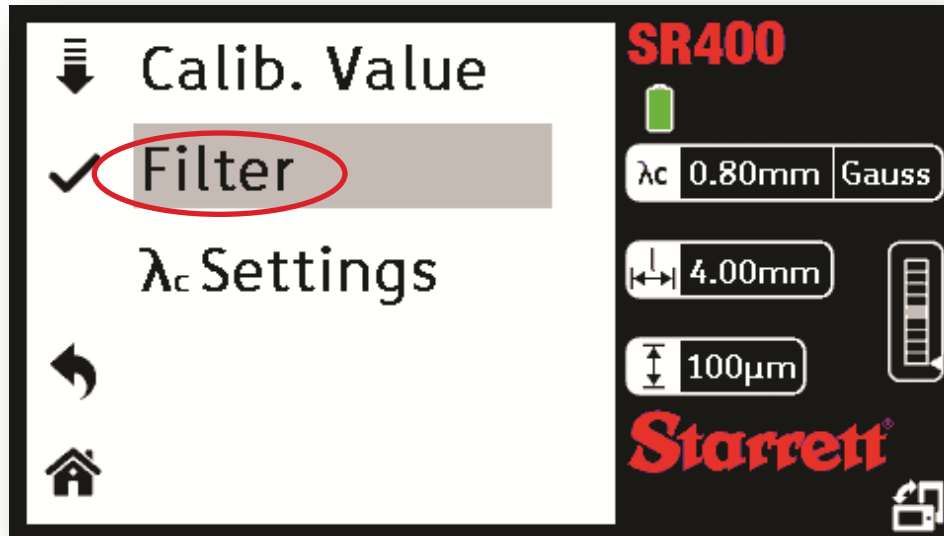

Instructions

Instruction Menu



SR300 and SR400 Surface Roughness Tester

Calibration Settings

Tap "Settings" to enter your required calibration options.

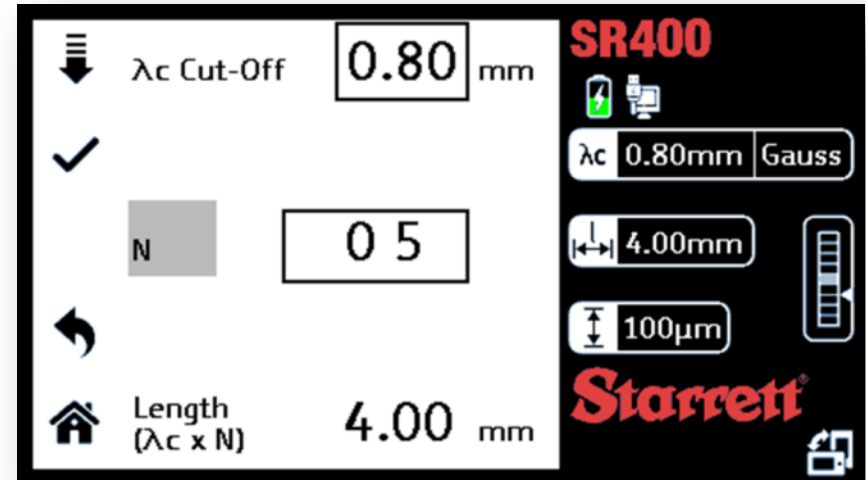
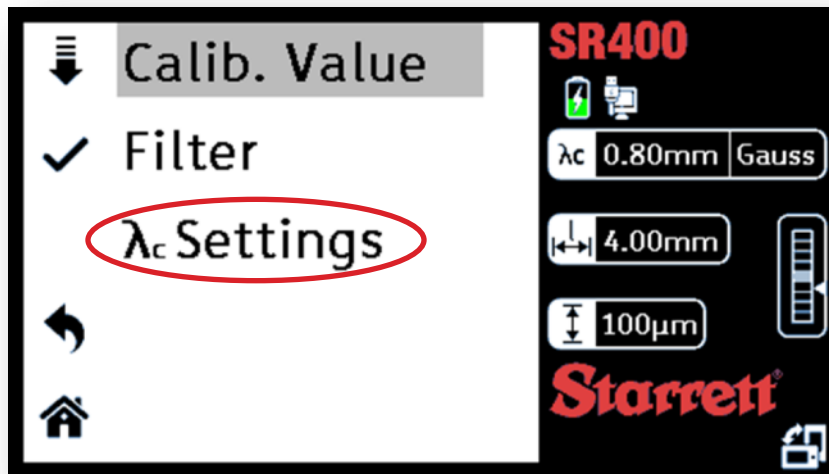

Instructions

Instruction Menu



SR300 and SR400 Surface Roughness Tester

Cut-Off

Tap the "Cut-off" icon to edit the length.

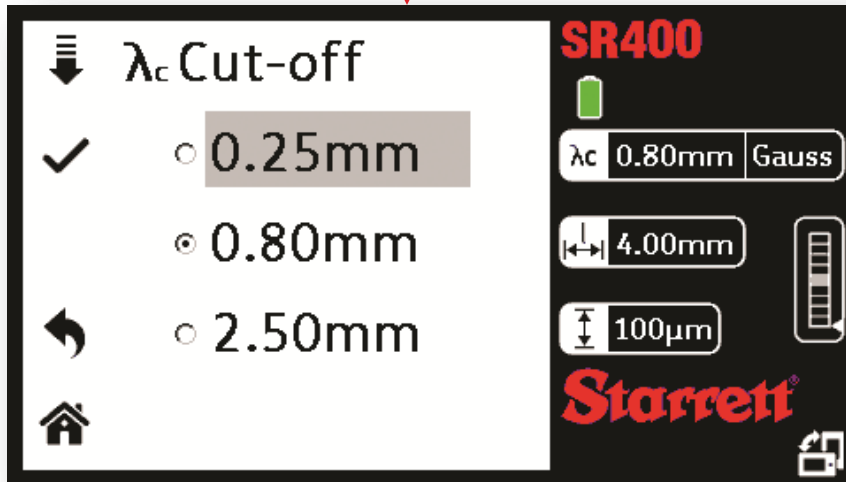
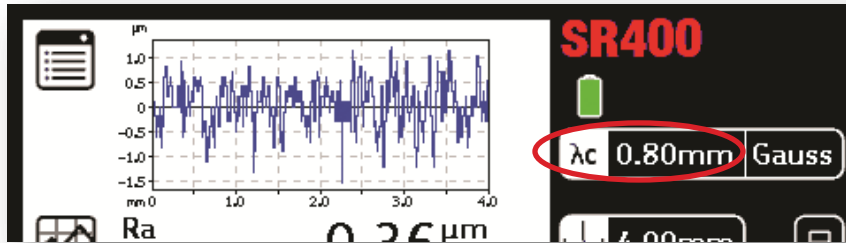

Filter Type

Tap the "Filter" icon to edit the type.

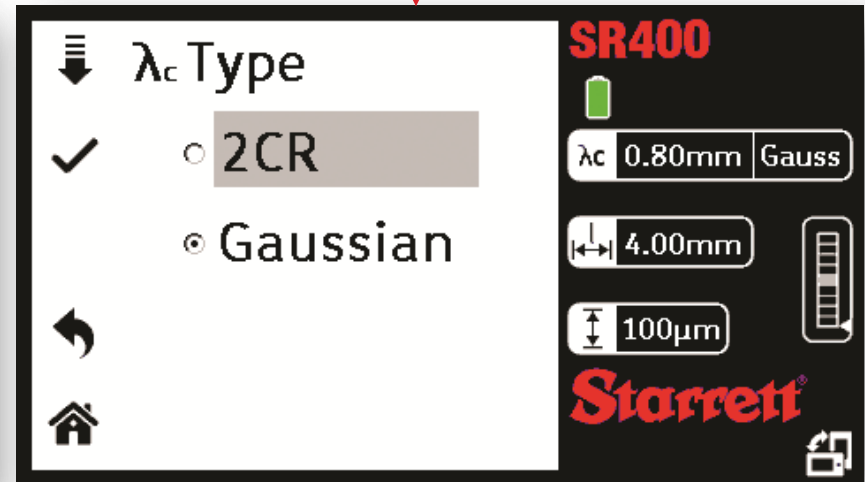
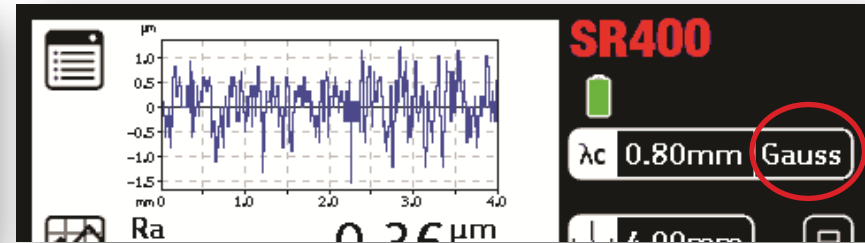

Instructions

Instruction Menu



SR300 and SR400 Surface Roughness Tester

Measurement Length

Tap the “Measurement” icon to edit the length.

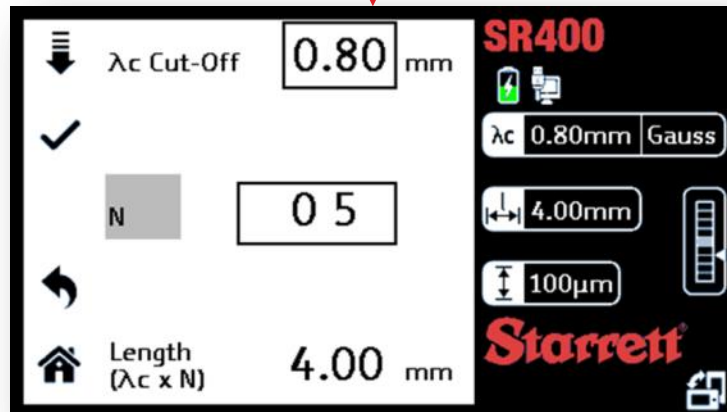
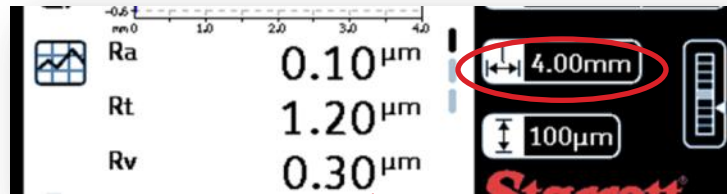

Range

Tap the “Range” icon to edit the range.

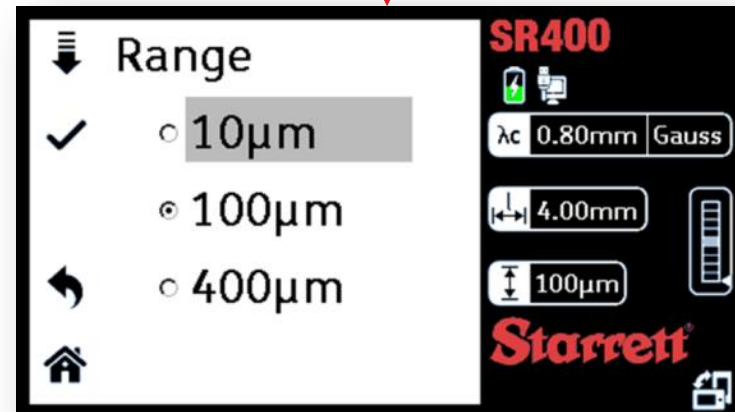
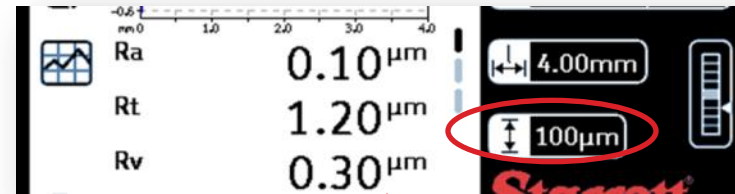

Instructions

Instruction Menu



SR300 and SR400 Surface Roughness Tester

ISO 4287

Tap "ISO 4287" to select parameters.

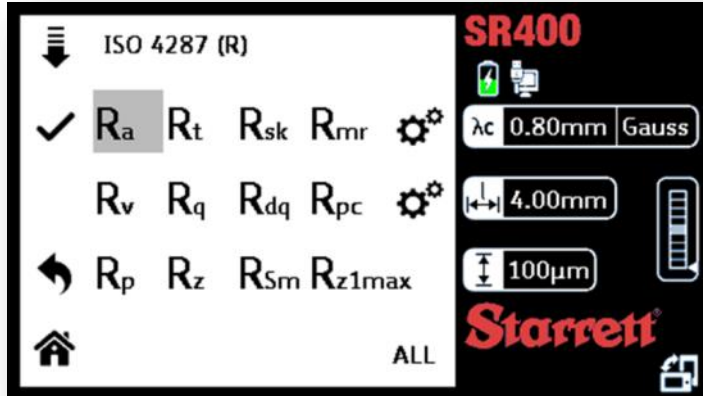
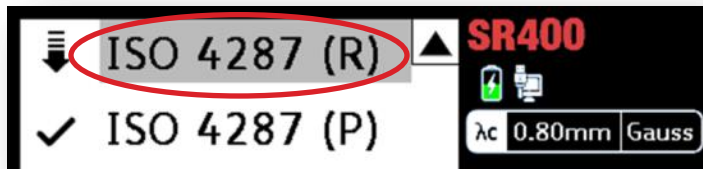

ISO 13565

Tap "ISO 13565" to select parameters.

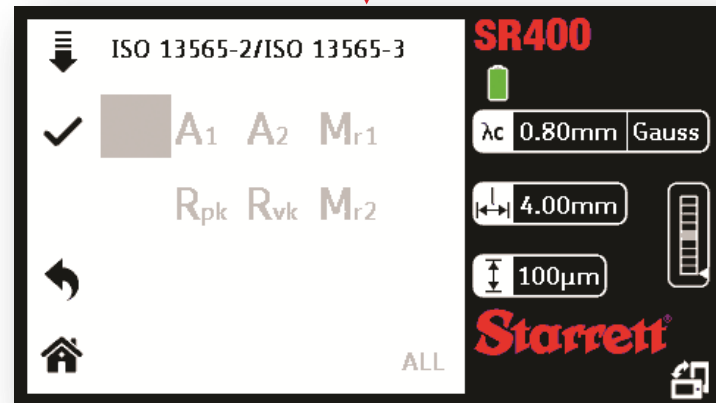
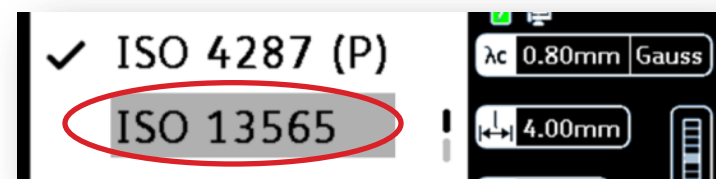

Instructions

Instruction Menu



SR300 and SR400 Surface Roughness Tester

ASME B46.1

Tap "ASME B46.1" to select parameters.

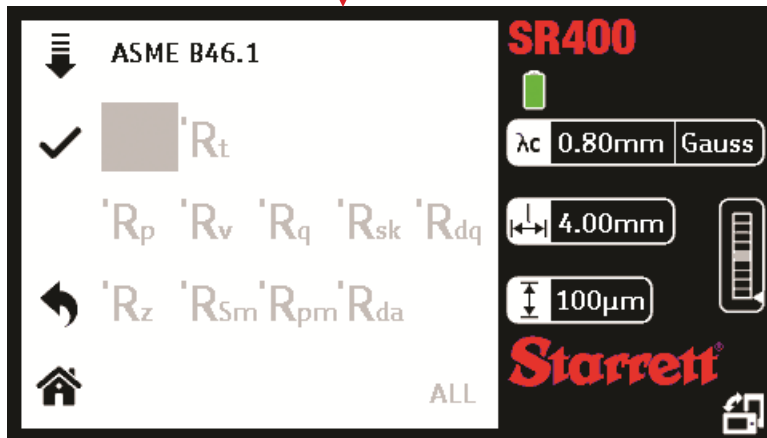

Others

Tap "Others" to select parameters.

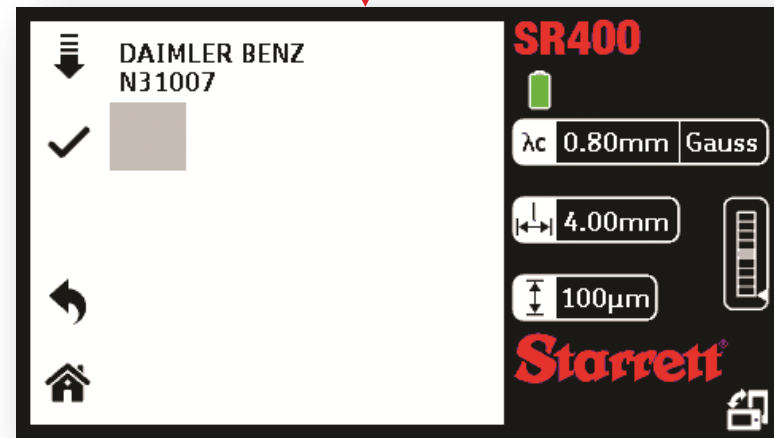

Instructions

Instruction Menu



SR300 and SR400 Surface Roughness Tester

Parameter Setting – “Rmr”

Tap “ISO 4287” and then the first “Settings” icon to open the “Rmr” settings.

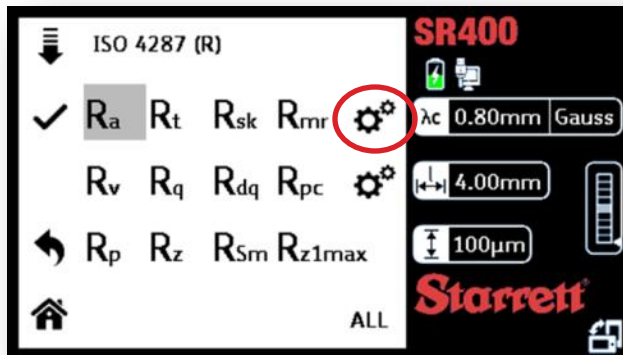
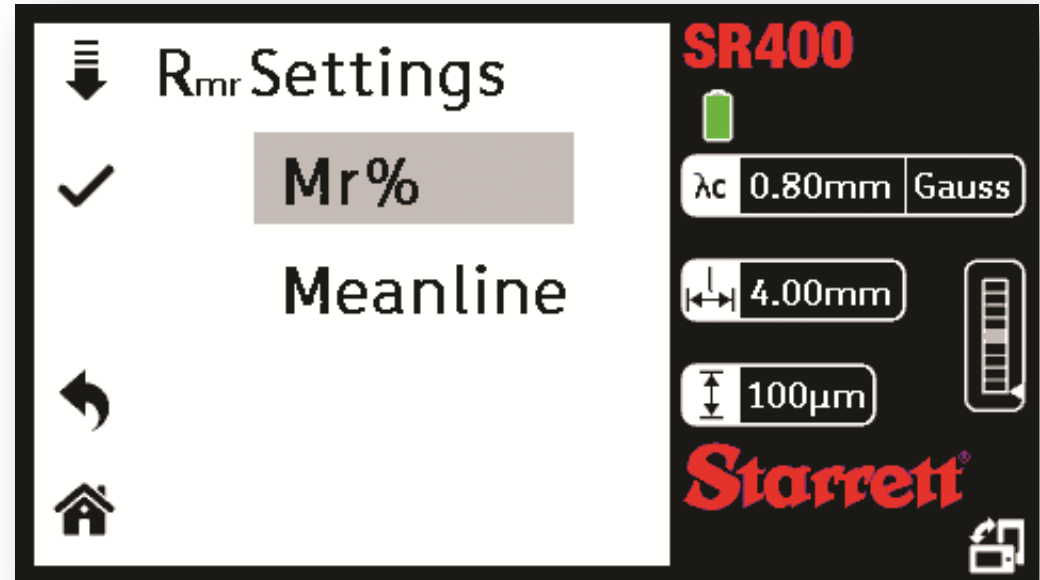
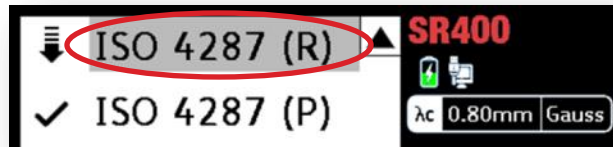

Instructions

Instruction Menu



SR300 and SR400 Surface Roughness Tester

Parameter Setting – “Mr%”

Tap “Mr%” and then the box where the number is displayed to adjust the setting.

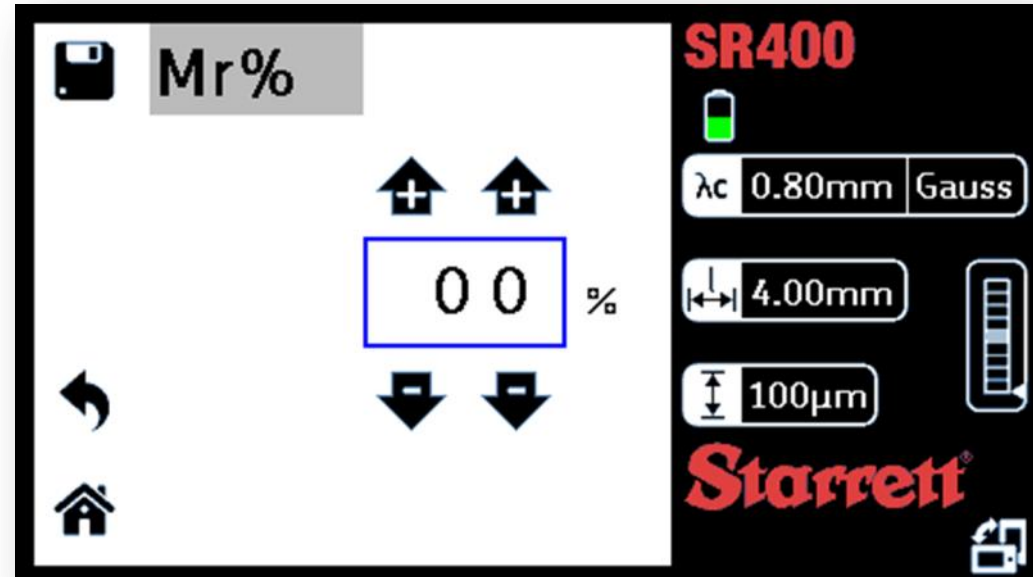
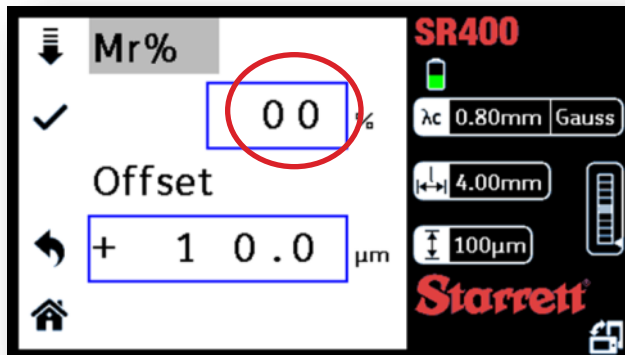
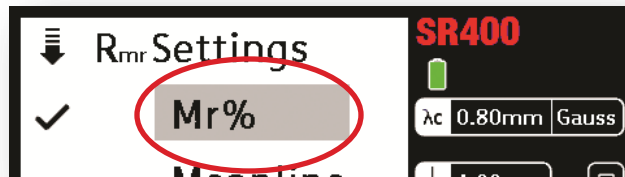

Instructions

Instruction Menu



SR300 and SR400 Surface Roughness Tester

Parameter Setting – “Mr%”

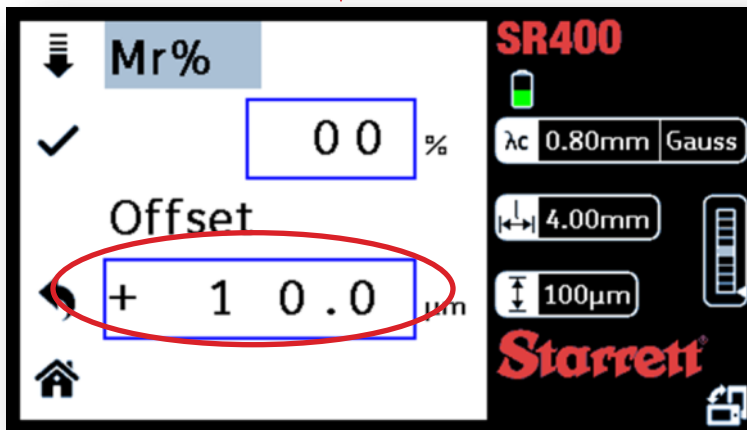
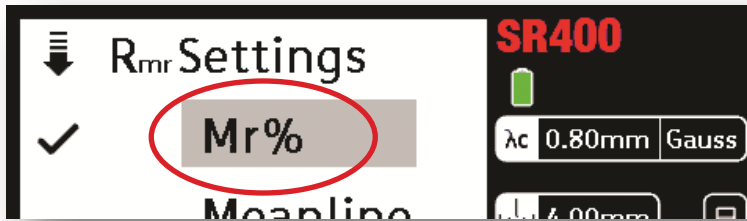

Tap “Mr%” and then the “Offset” box to adjust the setting.

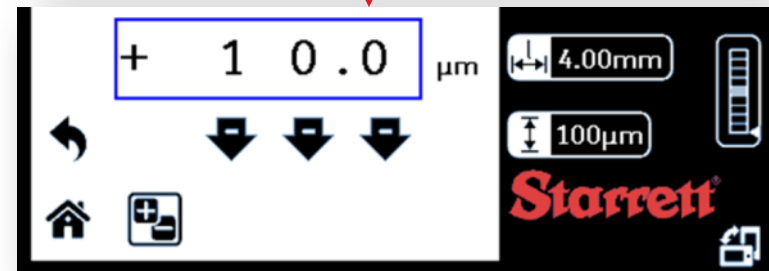
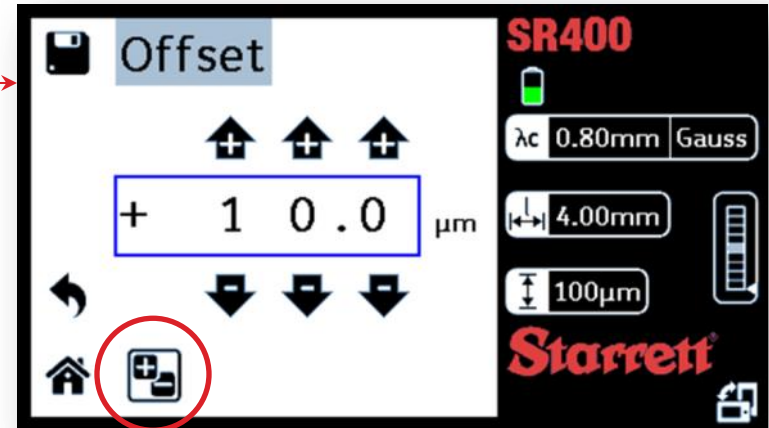

Tap “+/-” icon to select between positive and negative.

Instructions

Instruction Menu



SR300 and SR400 Surface Roughness Tester

Parameter Setting – “Meanline”

Tap “Meanline” to adjust the setting.

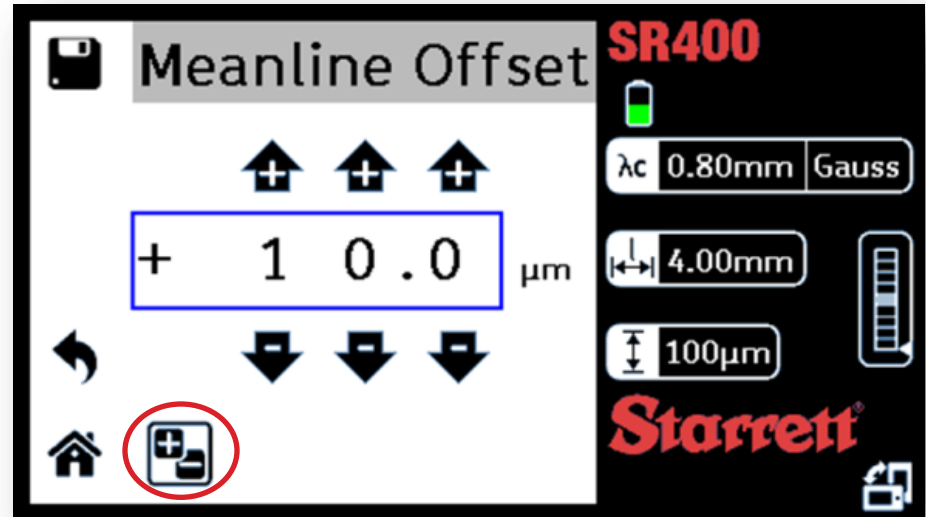
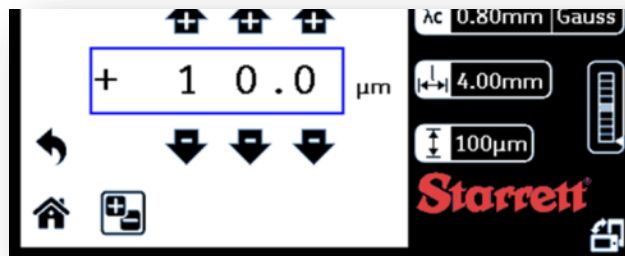
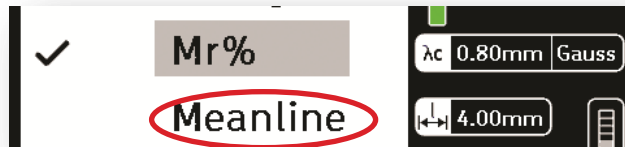

Tap “+/-” icon to select between positive and negative.

Instructions

Instruction Menu



SR300 and SR400 Surface Roughness Tester

Parameter Setting – “R_{pc}”

Tap “ISO 4287” and then the second “Settings icon to adjust the “R_{pc} Bandwidth”.

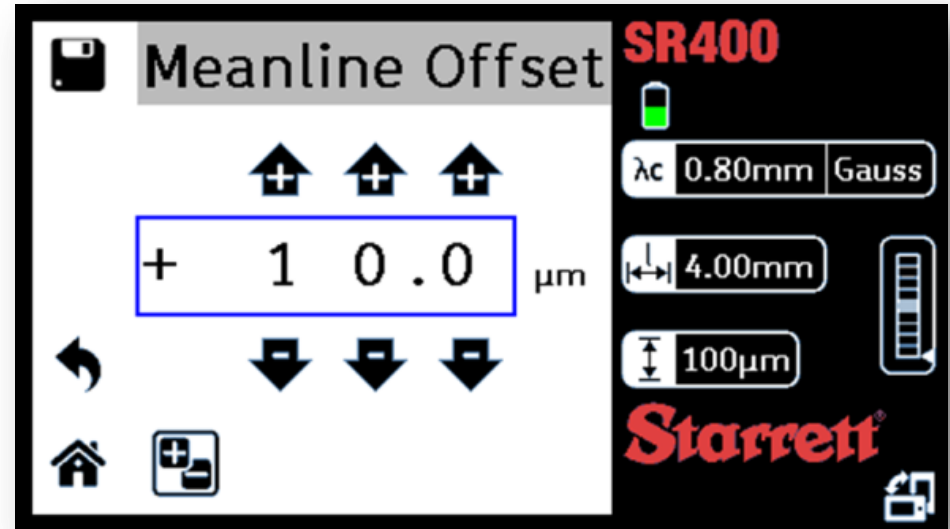
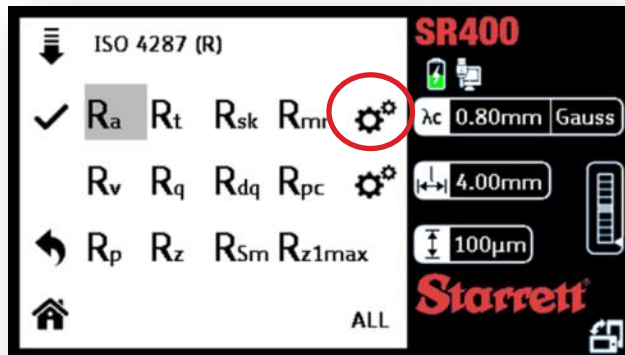
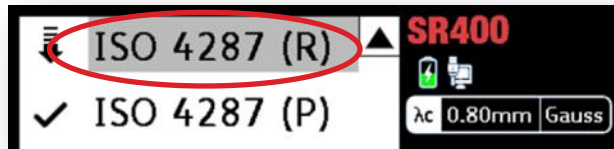

Instructions

Instruction Menu



SR300 and SR400 Surface Roughness Tester

Units

Tap "Units" to select between "Metric" and "English".

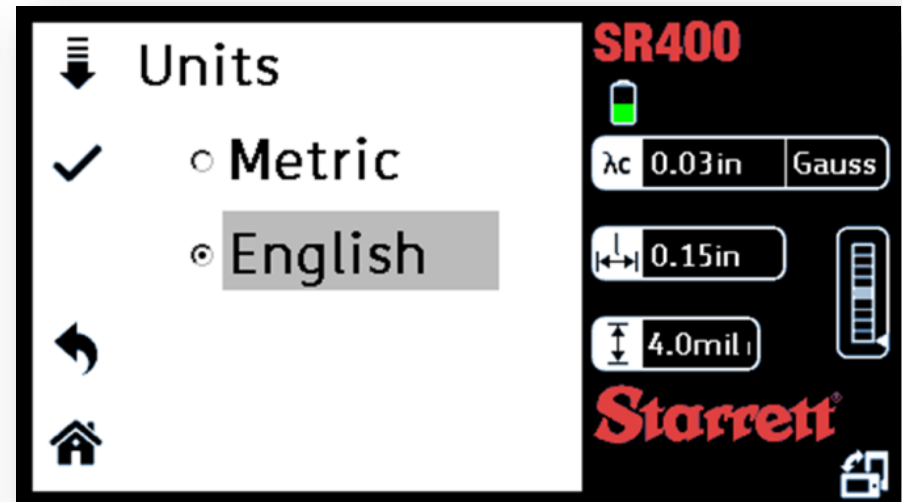
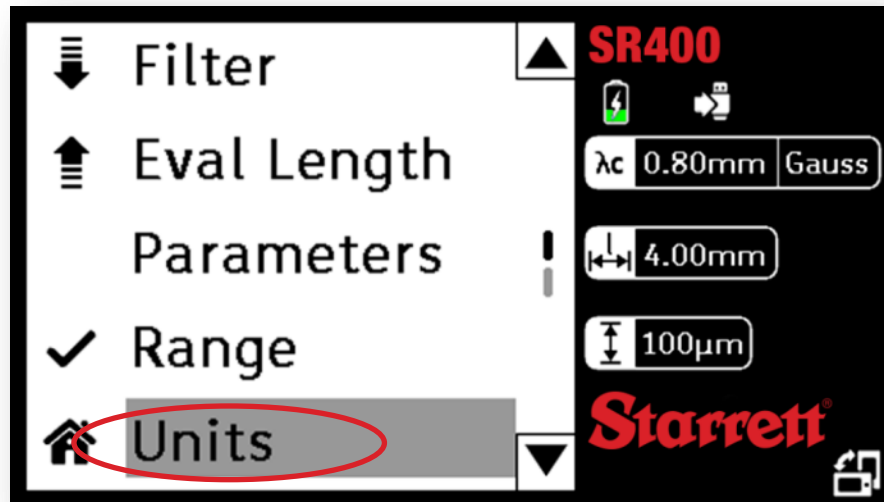

Instructions

Instruction Menu



SR300 and SR400 Surface Roughness Tester

Storage

Tap "Store" and then "Store Mode" to select which storage option you require.

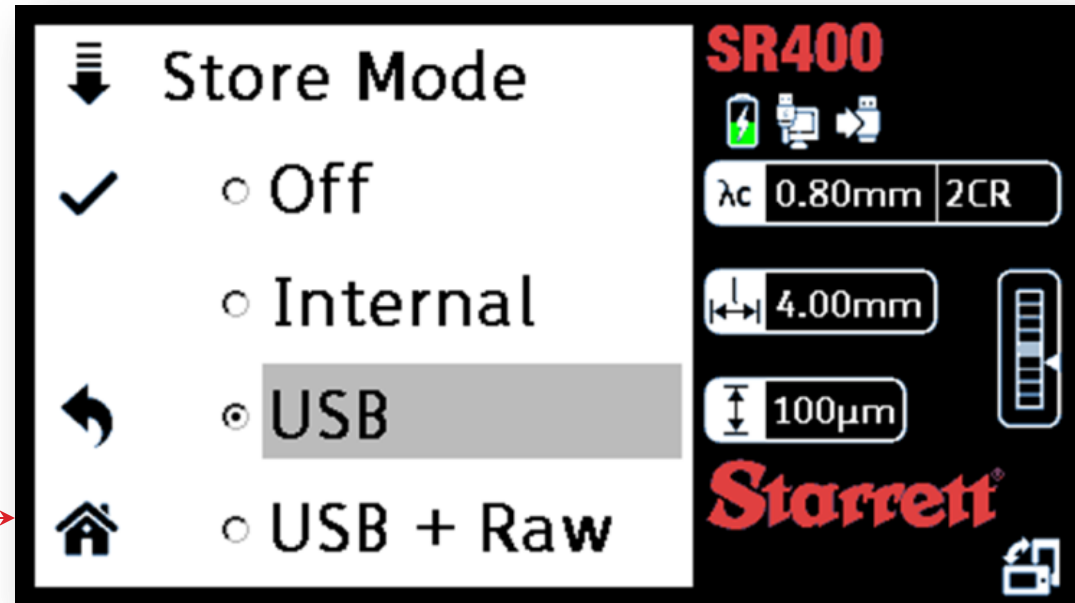
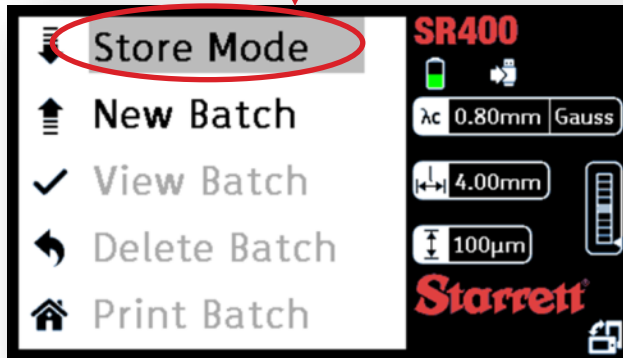
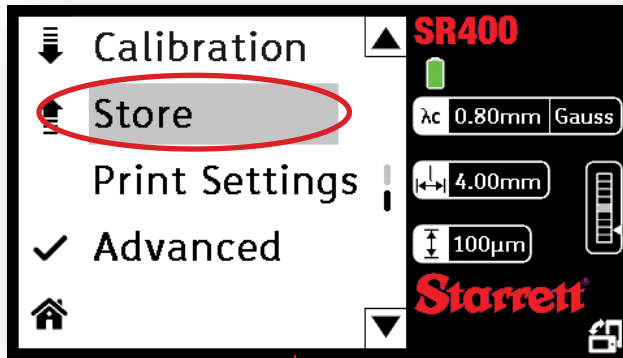

Instructions

Instruction Menu



SR300 and SR400 Surface Roughness Tester

New Batch

Tap "Store" and then "New Batch" to create a new batch.

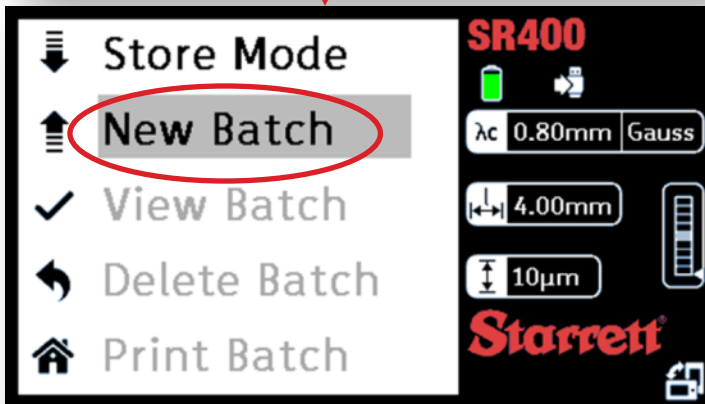
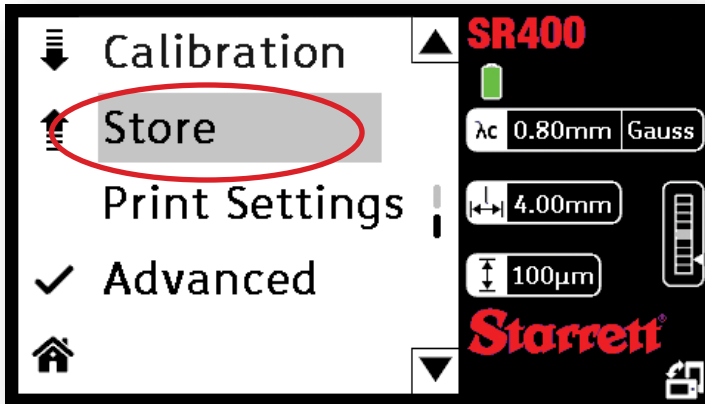

Enter a "Batch Name" and tap "Save"

- The Name must be 5 digits or less.

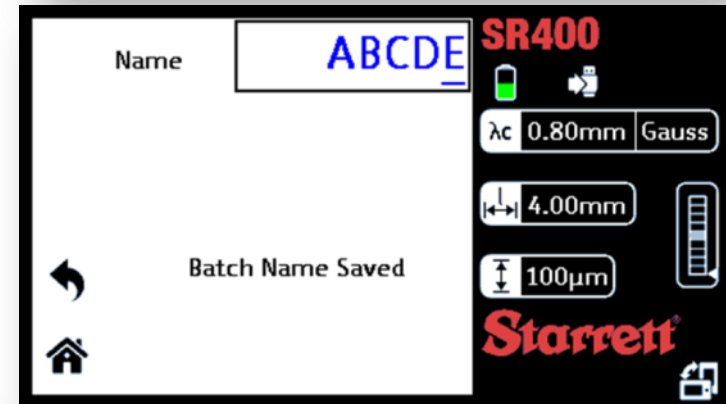
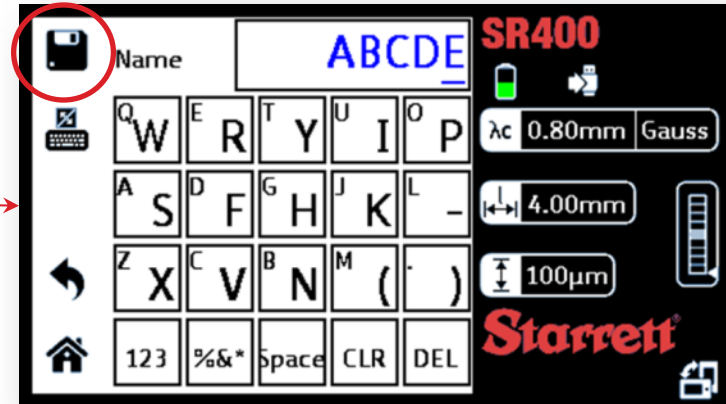

Instructions

Instruction Menu



SR300 and SR400 Surface Roughness Tester

Keyboard

Tap “Keyboard” icon to switch between the two keyboard values.

Tap “Number” or “Symbol” icons to enter either numbers or symbols in the “Batch Name”.

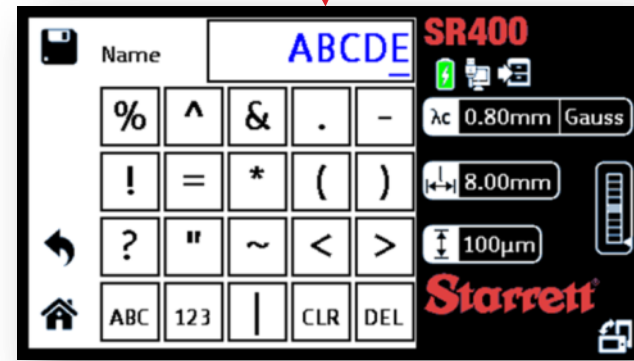
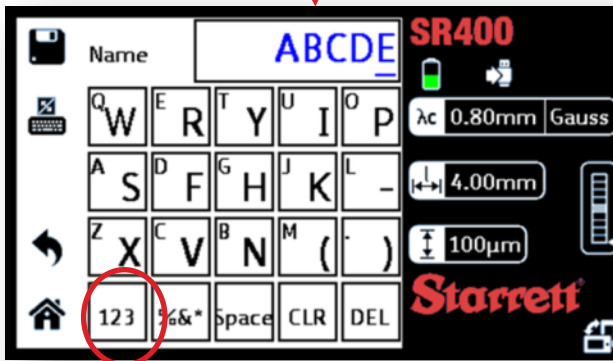
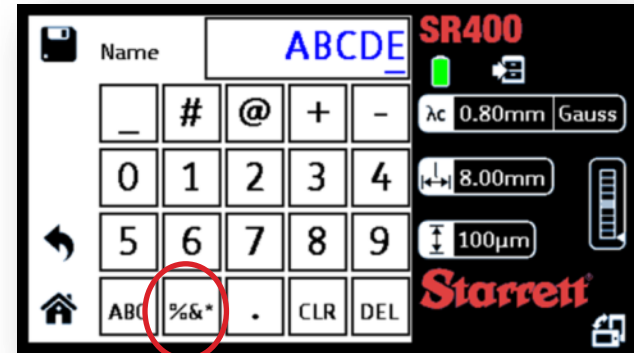
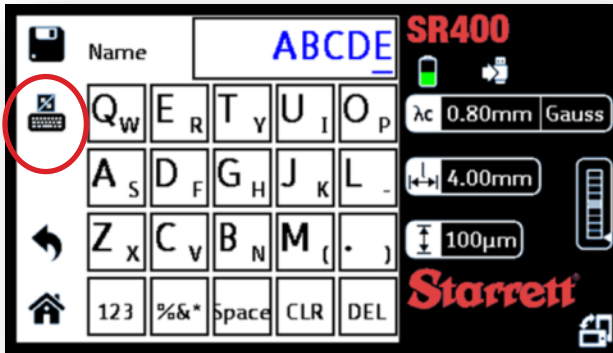

Instructions

Instruction Menu



SR300 and SR400 Surface Roughness Tester

View Batch

Tap “Store” and then “View Batch” to view all saved data.

Tap the “Batch Name” to view the data in more detail.

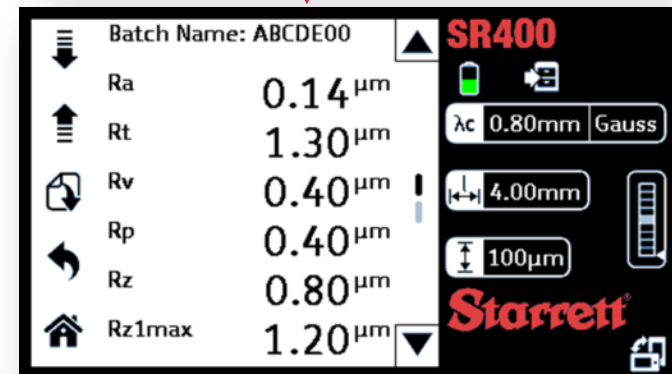
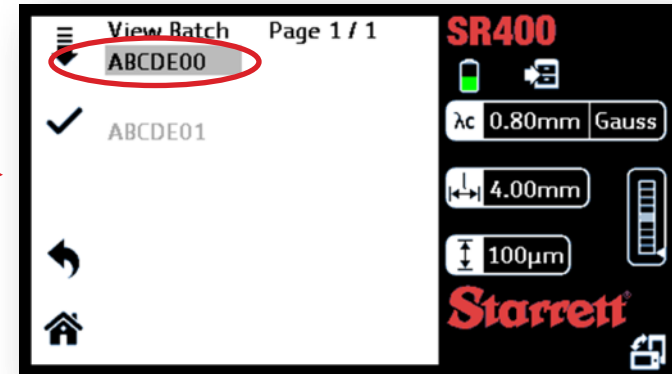
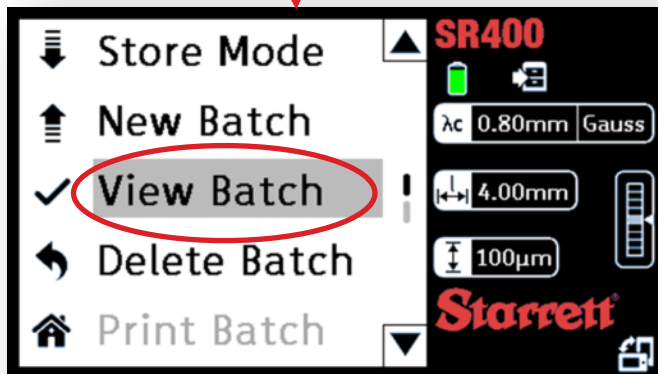
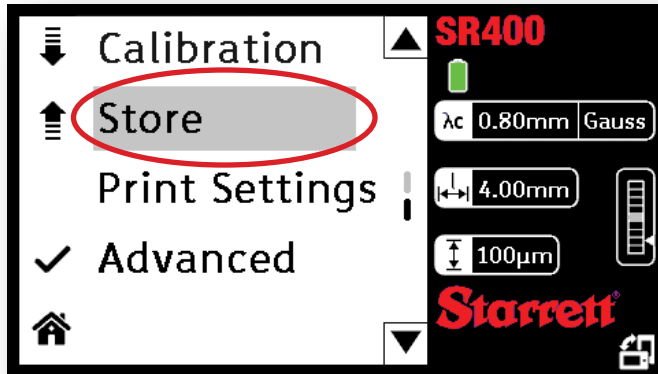

Instructions

Instruction Menu



SR300 and SR400 Surface Roughness Tester

Delete Batch

Tap “Store” and then “Delete Batch” and then select a batch.

Tap the “Trash” icon to delete the selected batch. Tap the “Trash” icon again to confirm the deletion of the batch.

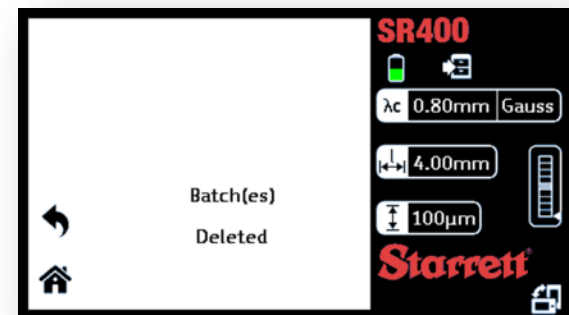
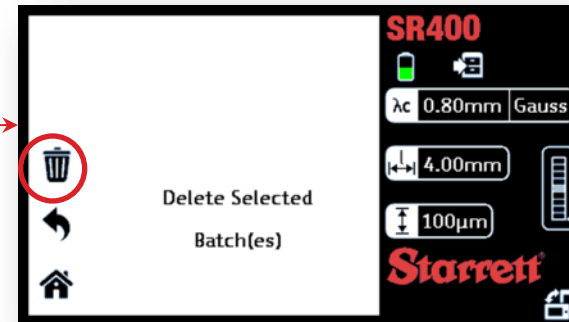
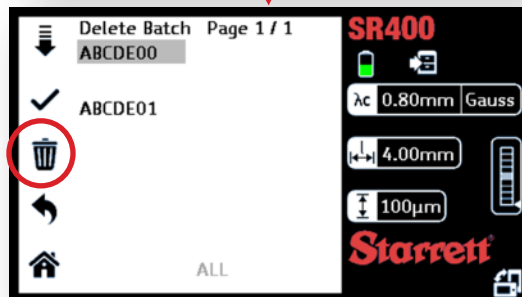
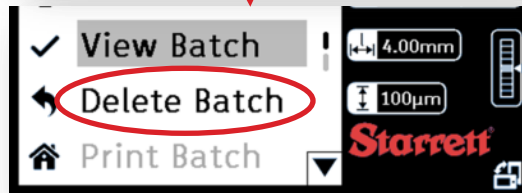
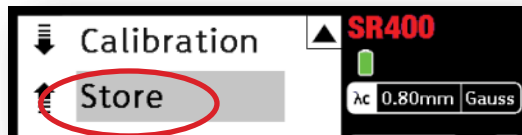

Instructions

Instruction Menu



SR300 and SR400 Surface Roughness Tester

Print Batch

Tap "Store" and then "Print Batch" to view all saved batches.

Tap the "Batch Name" and then the "Print" icon to print the batch.

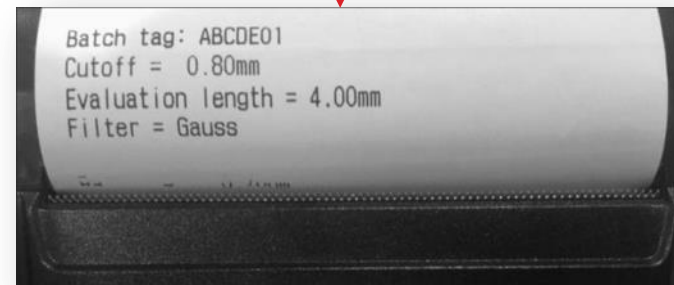
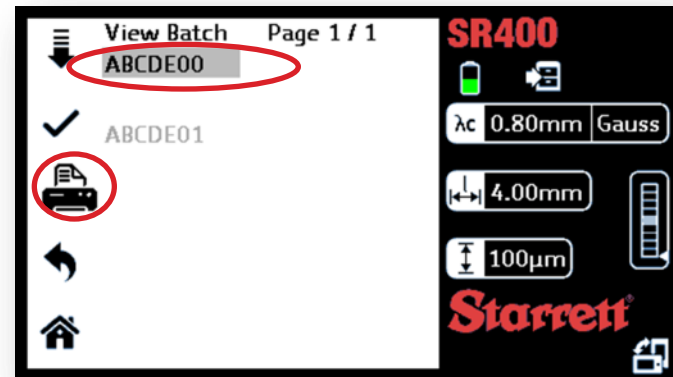
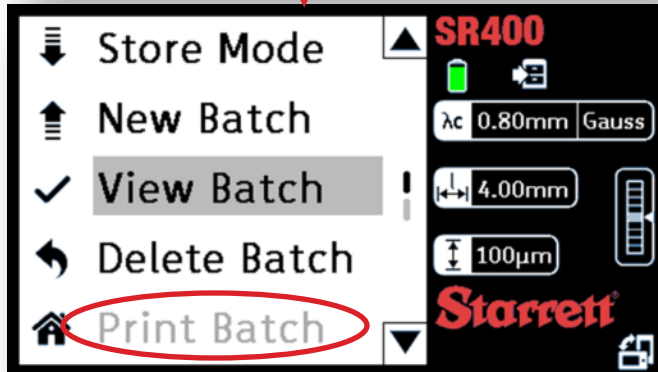
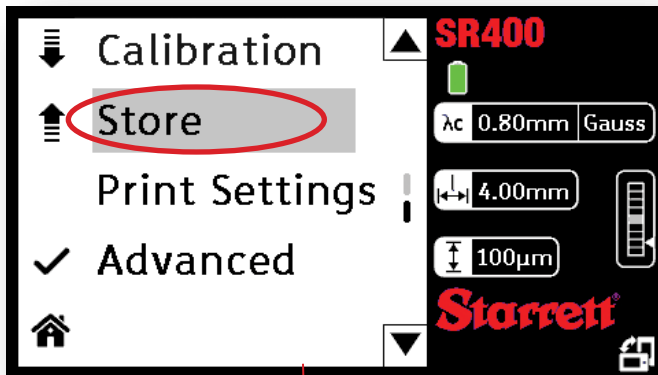

Instructions

Instruction Menu



SR300 and SR400 Surface Roughness Tester

Print

Tap "Print Settings" to select your required printing options.

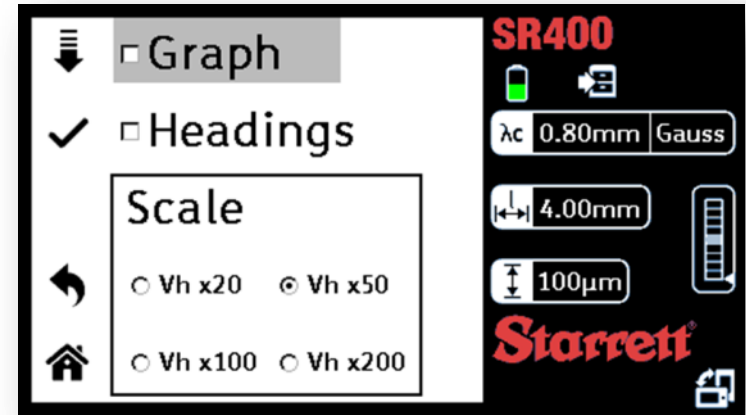
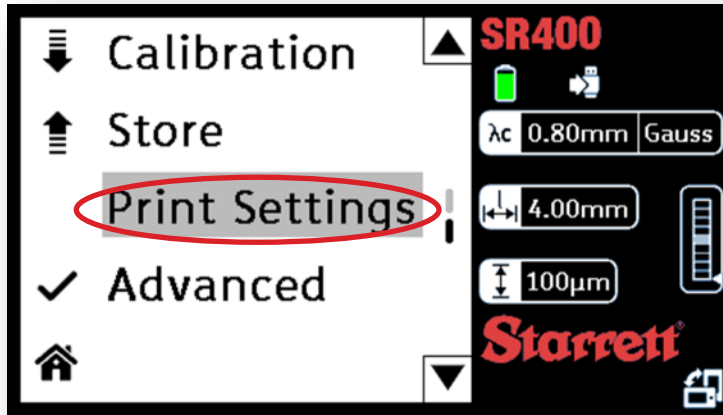

This icon shows that a printer is connected to the device.

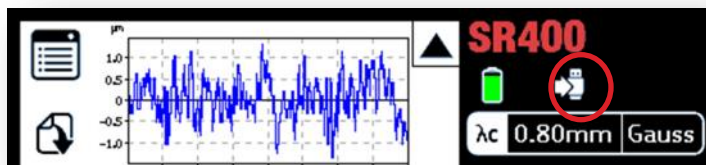

Tap the "Printer" icon on the home screen to print the measurement.

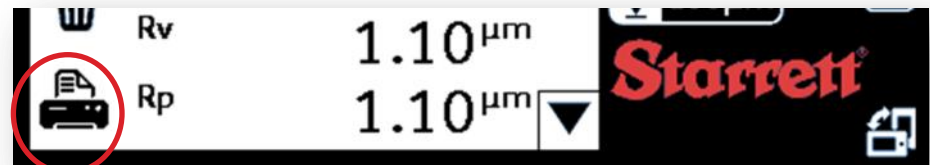

Instructions

Instruction Menu



SR300 and SR400 Surface Roughness Tester

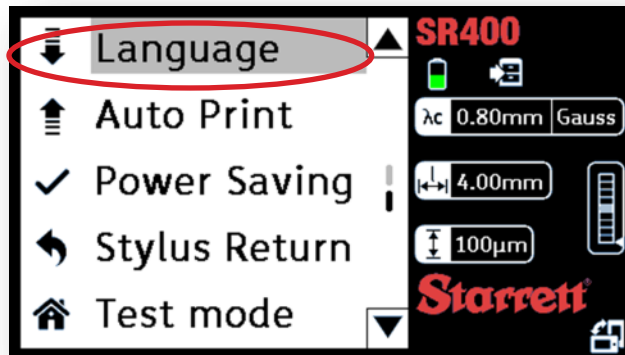
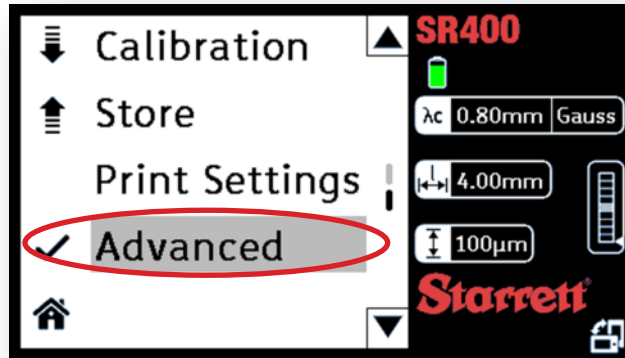

Language

Tap "Advanced" and then "Language" to select which language you require.

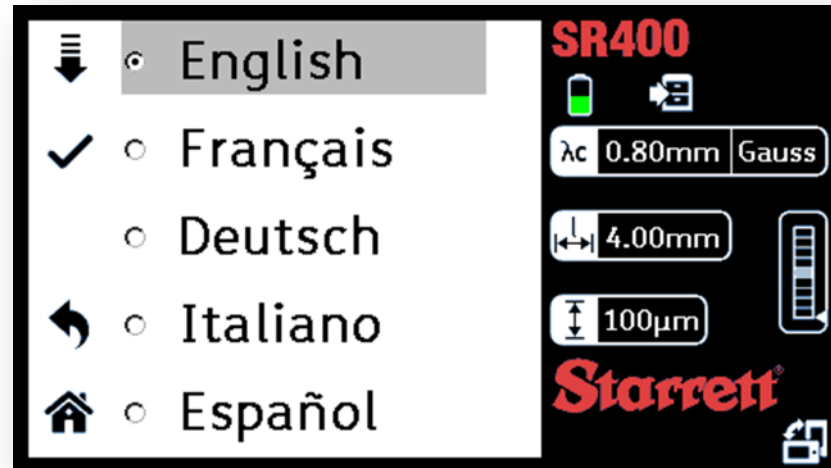

Instructions

Instruction Menu



SR300 and SR400 Surface Roughness Tester

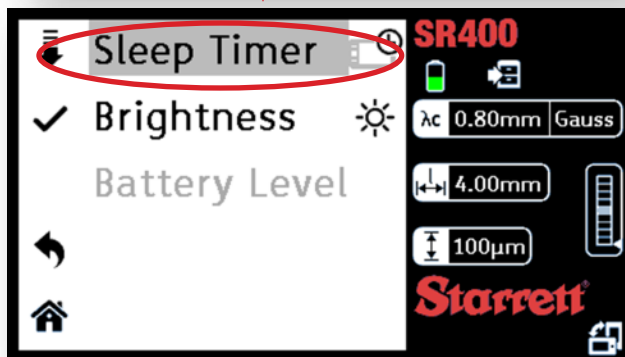
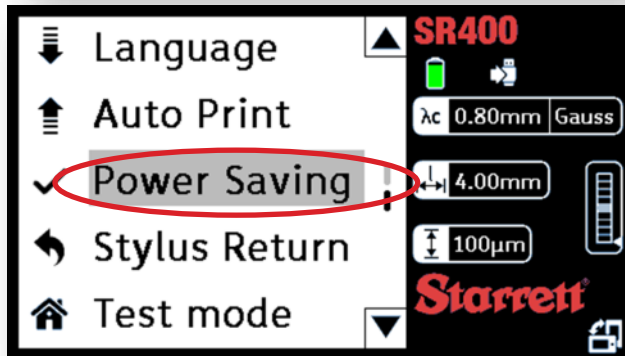
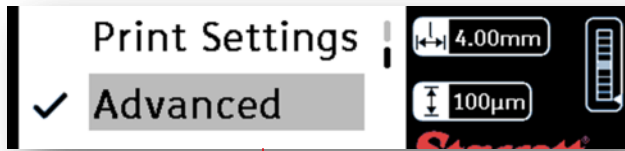

Sleep Timer - Battery

Tap "Advanced" then "Power Saving" and then "Sleep Timer".
Select "Battery" and set a time as the battery sleep timer.

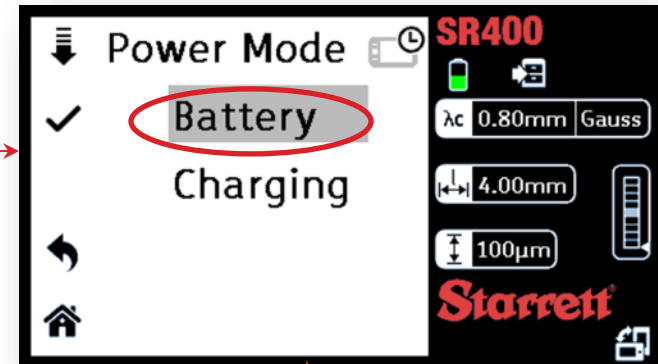

Instructions

Instruction Menu



SR300 and SR400 Surface Roughness Tester

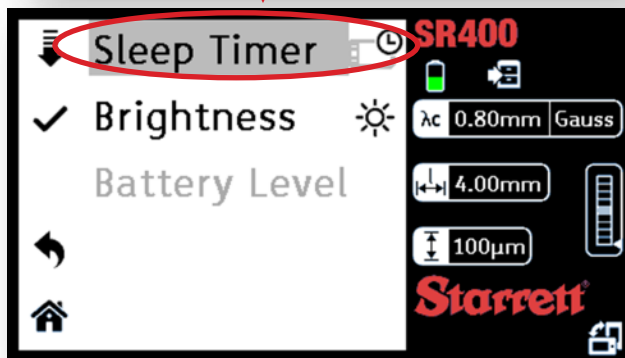
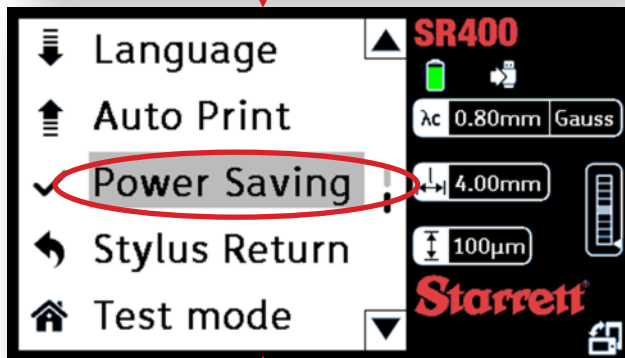
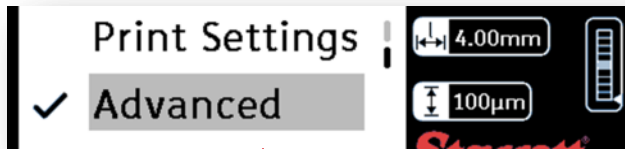

Sleep Timer - Charging

Tap "Advanced" then "Power Saving" and then "Sleep Timer".
Select "Charging" and set a time as the charging sleep timer.

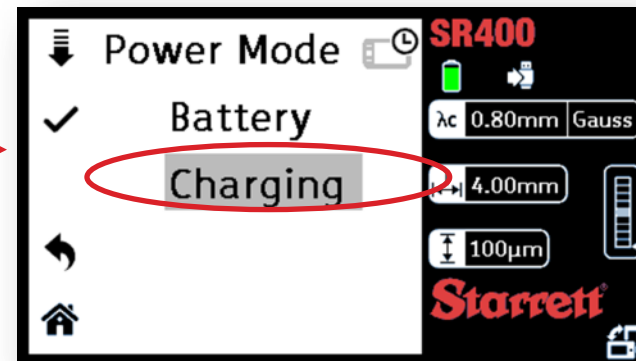

Instructions

Instruction Menu



SR300 and SR400 Surface Roughness Tester

Brightness

Tap “Advanced” then “Power Saving” and then select “Brightness”.

Set the brightness to the percentage you require.

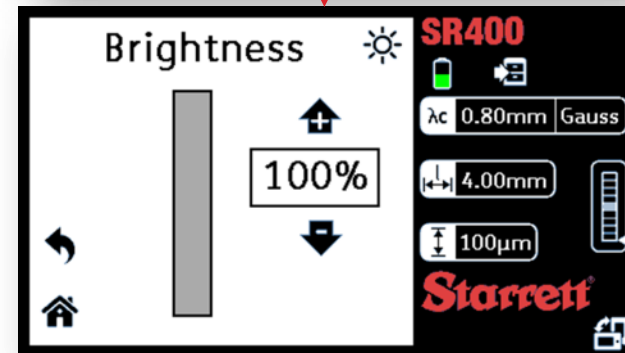
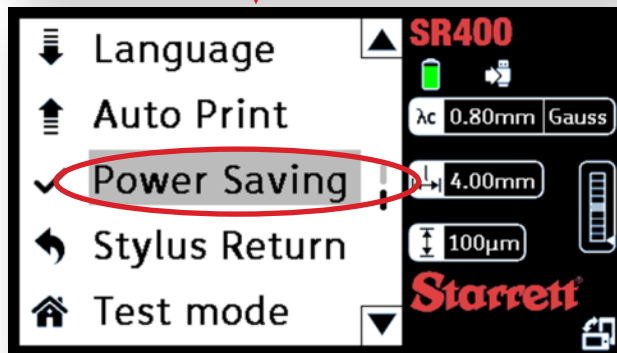
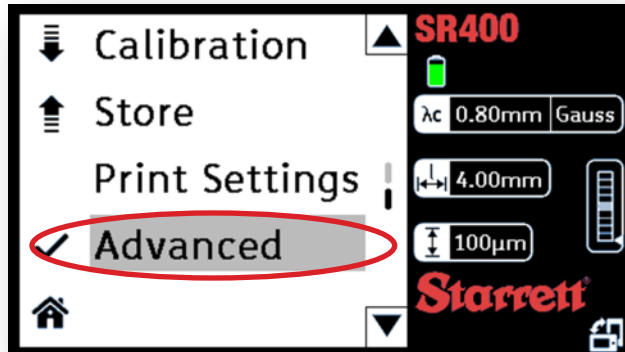

Instructions

Instruction Menu



SR300 and SR400 Surface Roughness Tester

Battery Level

Tap “Advanced” then “Power Saving” and then select “Battery Level” to view the current battery level of your device.

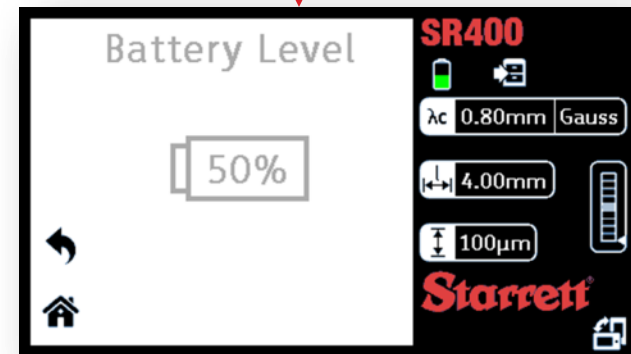
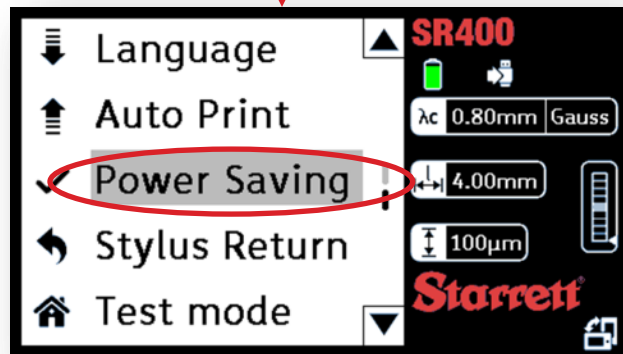
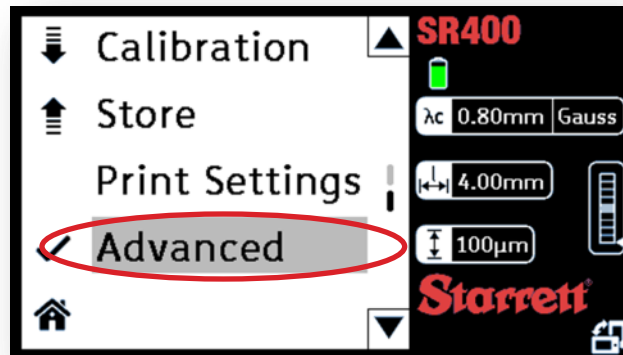

Instructions

Instruction Menu



SR300 and SR400 Surface Roughness Tester

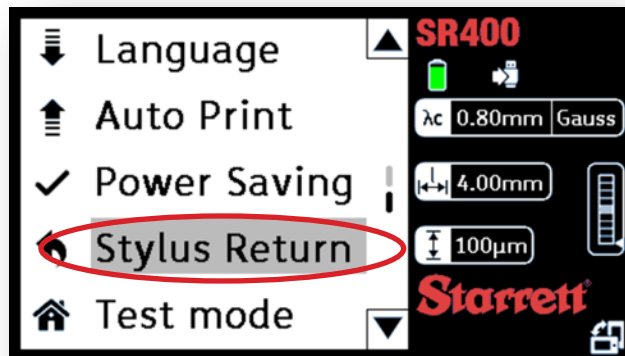
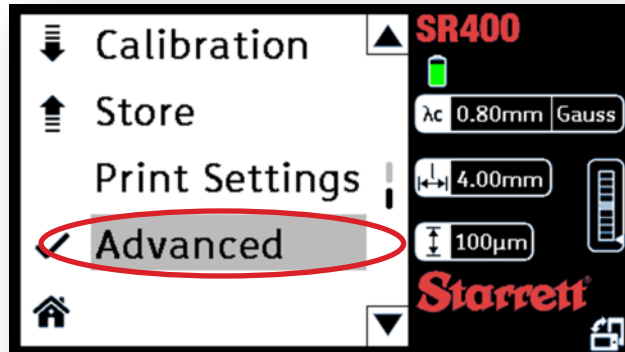

Stylus Return

Tap "Advanced" and then "Stylus Return" to select which option you require.

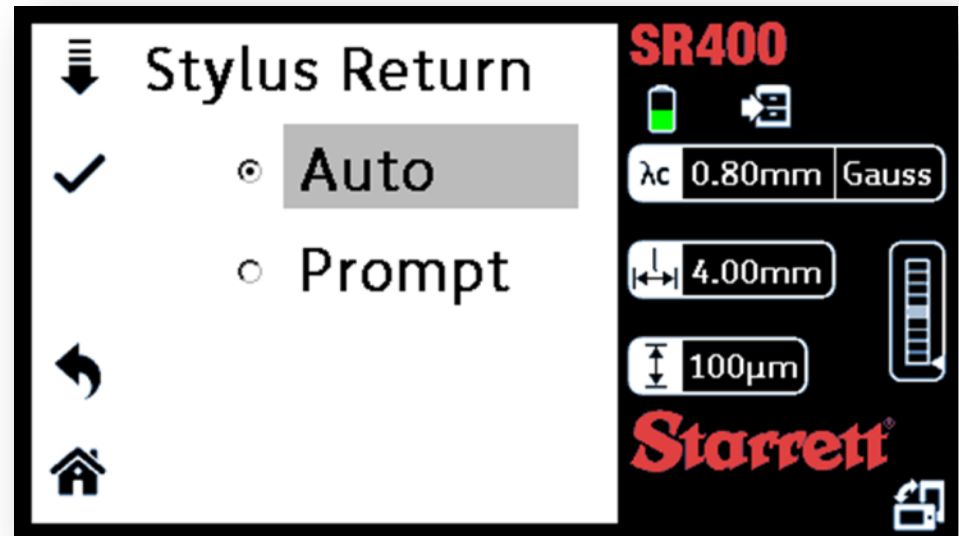

Instructions

Instruction Menu



SR300 and SR400 Surface Roughness Tester

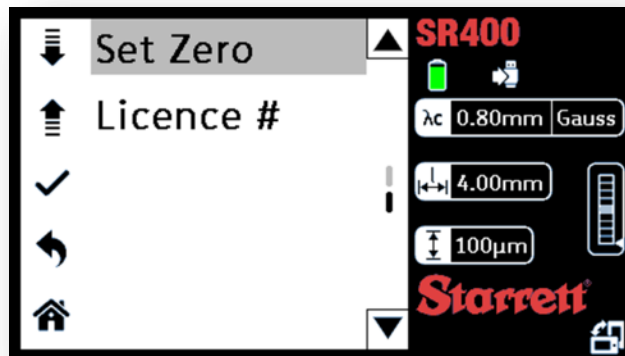
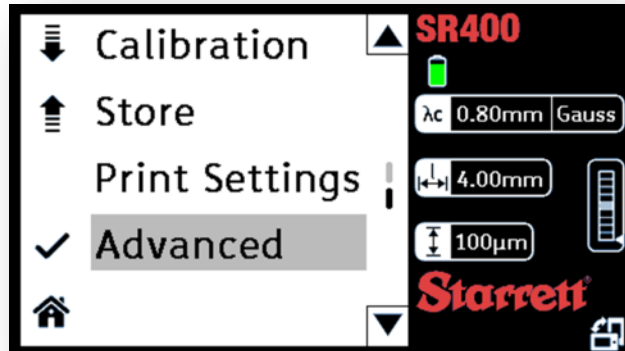

Set Zero

Tap “Advanced” and then “Set Zero”. Then place unit on a flat surface and press measure. This will center the gage range.

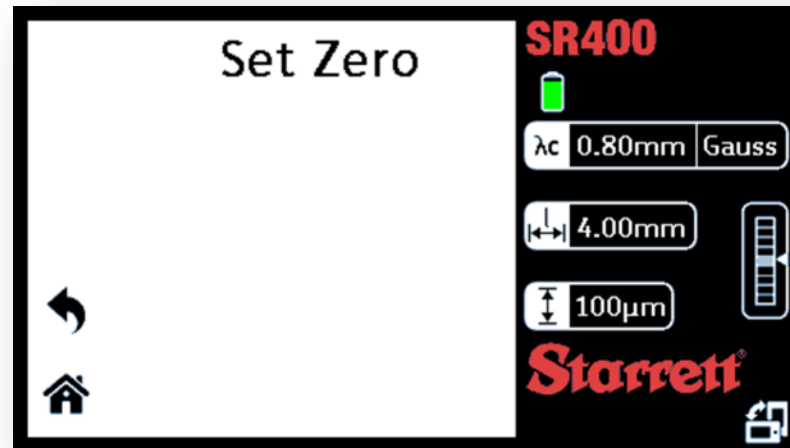



SR300 AND SR400 - SURFACE ROUGHNESS TESTER USER GUIDE

Starrett®

THE L.S. STARRETT COMPANY

121 Crescent Street
Athol, MA 01331
starrett.com

SR300 AND SR400 USER MANUAL

Form 980

PDF 11/13

Specifications subject to change.